

NOTICE!!

These documents have been scanned!

Do not place un-scanned documents beneath this notice!

Do not remove this notice from this file!

GPO Jacket No. 560-102
Print Order 61540
Rise Business Services, LLC
Job=AZ15 4/29/2019



Box Number= AZ15006



Claim Begin-End: AMC445836-AMC445838

1 Initial Receipt



AZ15006-37 AMC450400-AMC453366

United States Department of the Interior
Bureau of Land Management
 DIV OF LANDS, MINRLS & ENERGY
 ONE N CENTRAL AVE
 PHOENIX, AZ 85004 -4427
 Phone: 602-417-9200

Receipt

No: 3982453

Transaction #: 4092609	
Date of Transaction: 09/22/2017	
CUSTOMER:	
FREEPORT MCMORAN BAGDAD INC PO BOX 245 BAGDAD, AZ 86321-0245 US	

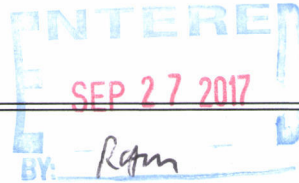

LINE #	QTY	DESCRIPTION	REMARKS	UNIT PRICE	TOTAL
1	3.00	LOCATABLE MINERALS / MINING CLAIMS-NEW, UNADJUD, ONE OR MORE AUTH NOS / NEW MINING CLAIM PROCESSING FEE CASES: AMC445836/\$20.00, AMC445837/\$20.00, AMC445838/\$20.00		- n/a -	60.00
2	3.00	LOCATABLE MINERALS / MINING CLAIMS-NEW, UNADJUD, ONE OR MORE AUTH NOS / NEW MINING CLAIMS LOCATION FEE CASES: AMC445836/\$37.00, AMC445837/\$37.00, AMC445838/\$37.00		- n/a -	111.00
3	3.00	LOCATABLE MINERALS / MINING CLAIMS-NEW, UNADJUD, ONE OR MORE AUTH NOS / NEW MINING CLAIMS MAINTENANCE FEE CASES: AMC445836/\$155.00, AMC445837/\$155.00, AMC445838/\$155.00		- n/a -	465.00
TOTAL:					\$636.00

PAYMENT INFORMATION				
1	AMOUNT:	636.00	POSTMARKED:	N/A
	TYPE:	CHECK	RECEIVED:	09/22/2017
	CHECK NO:	0000884111		
	NAME:	FREEPORT MCMORAN BAGDAD INC PO BOX 245 BAGDAD AZ 86321-0245 US		

REMARKS

NOTICE!!

These documents have been scanned!

Do not place un-scanned documents beneath this notice!

Do not remove this notice from this file!

GPO Jacket No. 560-102
Print Order 61540
Rise Business Services, LLC
Job=AZ15 4/29/2019



Box Number= AZ15006



Claim Begin-End: AMC445836-AMC445838

2 Correspondence



AZ15006-37

AMC450400-AMC453366

**NO
DOCUMENTS
FOUND**

NO DOCUMENTS FOUND
NO DOCUMENTS FOUND

NOTICE!!

These documents have been scanned!

Do not place un-scanned documents beneath this notice!

Do not remove this notice from this file!

GPO Jacket No. 560-102
Print Order 61540
Rise Business Services, LLC
Job=AZ15 4/29/2019



Box Number= AZ15006



Claim Begin-End: AMC445836-AMC445838

3 Transfers



AZ15006-37

AMC450400-AMC453366

**NO
DOCUMENTS
FOUND**

NO DOCUMENTS FOUND
NO DOCUMENTS FOUND

NOTICE!!

These documents have been scanned!

Do not place un-scanned documents beneath this notice!

Do not remove this notice from this file!

GPO Jacket No. 560-102
Print Order 61540
Rise Business Services, LLC
Job=AZ15 4/29/2019



Box Number= AZ15006



Claim Begin-End: AMC445836-AMC445838

4 Annual Filings



AZ15006-37

AMC450400-AMC453366

364582 31840
 366982 38688
 62882
 63137
 79981
 159967
 305766
 308466
 317120
 322631
 362070

429339 397194
 435511 403441
 445836 413793
 418724
 422704
 423218²⁰¹⁸
 425400

August 1, 2018

After recording, return to:
 Freeport-McMoRan Inc.
 Attn: C. Loder
 333 North Central Avenue
 Phoenix, AZ 85004

Bureau of Land Management
 Department of the Interior
 One N. Central Avenue
 Phoenix, AZ 85004

NOTICE OF INTENT TO HOLD MINING CLAIMS AND PAYMENT OF BLM MAINTENANCE FEE

Re: Payment of Annual Claim Maintenance Fee

Dear Sir or Madam:

This will serve as notice that Freeport-McMoRan Bagdad, Inc., whose address for purposes of this filing is Land and Water Department, 333 North Central Ave., Phoenix, Arizona 85004, intends to hold the mining claims and/or mill sites described on Exhibit A attached hereto for the assessment year ending at 12 o'clock, noon, on September 1, 2019 by payment of the annual maintenance fee of \$155 per claim or site. Payment of such amount is made herewith for such assessment year for each of the claims and sites, the name, and BLM serial number with the book and page or index number of recording of the location notice in the official records of Yavapai County, Arizona, of which, is set forth on Exhibit A attached hereto and by this reference incorporated herein.

 Carolyn Loder for
 Freeport-McMoRan Bagdad, Inc.

State of Arizona)
) ss.
 County of Maricopa)

RECEIVED
 M AZ STATE OFFICE
 2018 AUG - 9 A 9:56
 PHOENIX, ARIZONA

The foregoing instrument was acknowledged before me on August 1st, 2018, by Carolyn Loder, on behalf of Freeport-McMoRan Bagdad, Inc.

(Seal)

 **STEPHANIE D. TURTON**
 Notary Public - State of Arizona
 MARICOPA COUNTY
 My Commission Expires Nov. 18, 2019

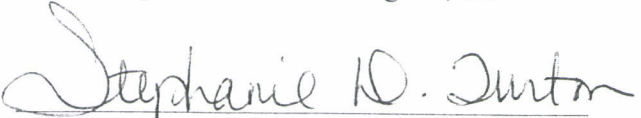
 Notary Public
 My commission expires: 11-18-2019

 **STEPHANIE D. TURTON**
 AUG 13 2018

EXHIBIT A

County: Yavapai

State: AZ

<u>BLM Serial #</u>	<u>Claim Name</u>	<u>Original Recording</u>		<u>Amended Recording</u>		<u>Location</u>
		<u>Recording #</u>	<u>Page #</u>	<u>Recording #</u>	<u>Page #</u>	
AMC 031840 7	RS 129	1185	243			SEC34-T15N-R10W
AMC 031841	RS 130	1185	245			SEC34-T15N-R10W
AMC 031842	RS 131	1185	247			SEC34-T15N-R10W
AMC 031843	RS 132	1185	249			SEC34-T15N-R10W
AMC 031844	RS 133	1185	251			SEC34-T15N-R10W
AMC 031845	RS 134	1185	253			SEC34-T15N-R10W
AMC 031846	RS 135	1185	255			SEC34-T15N-R10W
AMC 031847 J	RS 136	1185	257			SEC34-T15N-R10W
AMC 031856 7	RS 145	1185	275			SEC34-T15N-R10W
AMC 031857	RS 146	1185	277			SEC34-T15N-R10W
AMC 031858	RS 147	1185	279			SEC34-T15N-R10W
AMC 031859	RS 148	1185	281			SEC34-T15N-R10W
AMC 031860	RS 149	1185	283			SEC34-T15N-R10W
AMC 031861	RS 150	1185	285			SEC34-T15N-R10W
AMC 031862	RS 151	1185	287			SEC34-T15N-R10W
AMC 031863 J	RS 152	1185	289			SEC34-T15N-R10W
AMC 031872 7	RS 165	1185	307			SEC34-T15N-R10W
AMC 031873	RS 166	1185	309			SEC34-T15N-R10W
AMC 031874	RS 167	1185	311			SEC34-T15N-R10W
AMC 031875 J	RS 168	1185	313			SEC34-T15N-R10W
AMC 031884 7	RS 181	1185	331			SEC34-T15N-R10W
AMC 031885	RS 182	1185	333			SEC34-T15N-R10W
AMC 031886	RS 183	1185	335			SEC34-T15N-R10W
AMC 031887 J	RS 184	1185	337			SEC34-T15N-R10W
AMC 031896 7	RS 197	1185	355			SEC34-T15N-R10W
AMC 031897	RS 198	1185	357			SEC34-T15N-R10W
AMC 031898	RS 199	1185	359			SEC34-T15N-R10W
AMC 031899	RS 200	1185	361			SEC34-T15N-R10W
AMC 031900	RS 213	1185	363			SEC34-T15N-R10W
AMC 031901	RS 214	1185	365			SEC34-T15N-R10W
AMC 031902 J	RS 215	1185	367			SEC34-T15N-R10W
AMC 031903 J	RS 216	1185	369			SEC34-T15N-R10W
AMC 038690 7	DEER NO. 3	580	730			SEC12-T14N-R10W
AMC 038691	DEER NO. 4	580	731			SEC12-T14N-R10W
AMC 038692	DEER NO. 5	580	732			SEC12-T14N-R10W
AMC 038693	DEER NO. 6	580	733			SEC12-T14N-R10W
AMC 038694	DEER NO. 7A	1202	282			SEC12-T14N-R10W
AMC 038695 J	DEER NO. 8A	1202	284			SEC12-T14N-R10W

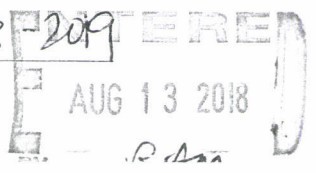
Date: 10/30/2017

RECEIVED
PHOENIX ARIZONA
2018 AUG - 9 AM
STATE OFFICE

NO. OF CLAIMS 1108 Page 1
 AMOUNT 176,740.00
 RECEIPT NO. 4230944

EXHIBIT A

County: Yavapai

State: AZ

<u>BLM Serial #</u>	<u>Claim Name</u>	<u>Original Recording</u>		<u>Amended Recording</u>		<u>Location</u>
		<u>Recording #</u>	<u>Page #</u>	<u>Recording #</u>	<u>Page #</u>	
AMC 038696 ←	DEER NO. 9	580	881			SEC12-T14N-R10W
AMC 038708 ↗	DEER # 21	669	962			SEC12-T14N-R10W
AMC 038709	DEER # 22	669	963			SEC12-T14N-R10W
AMC 038710	DEER # 23	669	964			SEC12-T14N-R10W
AMC 038711	DEER # 24	669	965			SEC12-T14N-R10W
AMC 038712	DEER # 25	669	966			SEC12-T14N-R10W
AMC 038713	DEER # 26	669	967			SEC12-T14N-R10W
AMC 038714	DEER # 27	669	968			SEC12-T14N-R10W
AMC 038715	DEER # 28	669	969			SEC13-T14N-R10W
AMC 038716	DEER # 29	669	970			SEC13-T14N-R10W
AMC 038717	DEER # 30	669	971			SEC12-T14N-R10W
AMC 038718	DEER # 31	669	972			SEC12-T14N-R10W
AMC 038719	DEER # 32	669	973			SEC12-T14N-R10W
AMC 038720	DEER # 33	669	974			SEC12-T14N-R10W
AMC 038721	DEER # 34	669	975			SEC13-T14N-R10W
AMC 038722	DEER # 35	669	976			SEC13-T14N-R10W
AMC 038723	DEER # 36	669	977			SEC13-T14N-R10W
AMC 038724	DEER # 37	669	978			SEC13-T14N-R10W
AMC 038725	DEER # 38	669	979			SEC12-T14N-R10W
AMC 038726	DEER # 39	669	980			SEC12-T14N-R10W
AMC 038727	DEER # 40	669	981			SEC12-T14N-R10W
AMC 038728	DEER # 41	669	982			SEC12-T14N-R10W
AMC 038729	DEER # 42	669	983			SEC13-T14N-R10W
AMC 038730	DEER # 43	669	984			SEC13-T14N-R10W
AMC 038731	DEER # 44	669	985			SEC13-T14N-R10W
AMC 038732	DEER # 45	669	986			SEC13-T14N-R10W
AMC 038733	DEER # 46	669	987			SEC13-T14N-R10W
AMC 038734	DEER # 47	669	988			SEC13-T14N-R10W
AMC 038735	DEER # 48	669	989			SEC11-T14N-R10W
AMC 038736	DEER # 49	669	990			SEC11-T14N-R10W
AMC 038737	DEER # 50	669	991			SEC14-T14N-R10W
AMC 038738	DEER # 51	669	992			SEC14-T14N-R10W
AMC 038739	DEER # 52	669	993			SEC14-T14N-R10W
AMC 038740	DEER # 53 (RELOCATION)	695	390			SEC13-T14N-R10W
AMC 038741	DEER # 54	669	995			SEC14-T14N-R10W
AMC 038742	DEER # 55	669	996			SEC14-T14N-R10W
AMC 038743	DEER # 56	669	997			SEC14-T14N-R10W
AMC 038744 ↘	DEER # 57	669	998			SEC14-T14N-R10W

Date: 10/30/2017

RECEIVED
 PLM AZ STATE OFFICE
 PHOENIX ARIZONA
 2016 AUG 29 AM 9:55

EXHIBIT A

County: Yavapai

State: AZ

BLM Serial #	Claim Name	Original Recording		Amended Recording		Location
		Recording #	Page #	Recording #	Page #	
AMC 038745	DEER # 58	669	999			SEC14-T14N-R10W
AMC 038746	DEER # 59	670	001			SEC14-T14N-R10W
AMC 038747	DEER # 60 (RELOCATION)	695	391			SEC14-T14N-R10W
AMC 038748	DEER # 61	670	003			SEC14-T14N-R10W
AMC 038749	DEER # 62	670	004			SEC14-T14N-R10W
AMC 038750	DEER # 63	670	005			SEC14-T14N-R10W
AMC 038751	DEER # 64	670	006			SEC14-T14N-R10W
AMC 038767	DEER # 81	938	474			SEC12-T14N-R10W
AMC 038768	DEER # 82	938	475			SEC12-T14N-R10W
AMC 038769	DEER # 83	938	476			SEC12-T14N-R10W
AMC 038770	DEER # 84	938	477			SEC12-T14N-R10W
AMC 062882	KEYNOTE	108	189			SEC20-T14N-R09W
AMC 062883	MOON ANCHOR	076	374			SEC19-T14N-R09W
AMC 062884	BIRD EYE	076	375			SEC19-T14N-R09W
AMC 062885	LONGVIEW	050	191	071	025	SEC30-T14N-R09W
AMC 062886	NINO	017	007			SEC19-T14N-R09W
AMC 062887	QUEEN EXTENSION #1	004	538			SEC20-T14N-R09W
AMC 062888	BRUCE #1	608	348			SEC19-T14N-R09W
AMC 062889	BRUCE #3	608	350			SEC19-T14N-R09W
AMC 062890	R & R #2	608	345			SEC18-T14N-R09W
AMC 062891	JOS #5	576	129			SEC19-T14N-R09W
AMC 062892	JOS #6	576	130			SEC19-T14N-R09W
AMC 062893	CYPRUS NO 1	005	483	025	589	SEC20-T14N-R09W
AMC 062894	CYPRUS NO 2	005	484	025	590	SEC20-T14N-R09W
AMC 062895	CYPRUS NO 3	005	485	025	591	SEC20-T14N-R09W
AMC 062896	CYPRUS NO. 4	013	022	049	525	SEC20-T14N-R09W
AMC 062897	CYPRUS NO. 5	013	023	049	526	SEC17-T14N-R09W
AMC 062898	CYPRUS NO 6	013	024	049	527	SEC20-T14N-R09W
AMC 062899	CYPRUS #7	049	528			SEC19-T14N-R09W
AMC 062900	CYPRUS #8	049	529			SEC19-T14N-R09W
AMC 062901	CYPRUS #9	049	530			SEC19-T14N-R09W
AMC 062902	CYPRUS #10	049	531			SEC19-T14N-R09W
AMC 062903	CYPRUS #11	049	532			SEC19-T14N-R09W
AMC 062904	CYPRUS #12	049	533			SEC19-T14N-R09W
AMC 062905	CYPRUS #13	049	534			SEC19-T14N-R09W
AMC 062906	CYPRUS # 14	071	024			SEC20-T14N-R09W
AMC 062907	CYPRUS #15	162	190			SEC18-T14N-R09W

Date: 10/30/2017

RECEIVED
 COUNTY CLERK
 YAVAPAI COUNTY
 OCT 31 2017
 10:50 AM

EXHIBIT A

County: Yavapai

State: AZ

BLM Serial #	Claim Name	Original Recording		Amended Recording		Location
		Recording #	Page #	Recording #	Page #	
AMC 062908	L. & W.	015	227			SEC19-T14N-R09W
AMC 062909	L. & W. NO. 3	015	230			SEC19-T14N-R09W
AMC 062910	L. & W. NO. 4	015	231			SEC19-T14N-R09W
AMC 062911	L & W. NO. 5	015	232			SEC19-T14N-R09W
AMC 062912	BETA NO. 1	013	546			SEC19-T14N-R09W
AMC 062913	BETA NO. 2	013	547	025	588	SEC19-T14N-R09W
AMC 062914	BETA NO. 3	013	548			SEC19-T14N-R09W
AMC 062915	PLYMOUTH	131	046			SEC17-T14N-R09W
AMC 062916	PLYMOUTH EXTENSION	156	246			SEC20-T14N-R09W
AMC 063176	OCTAROON	144	367			SEC14-T14N-R10W
AMC 063177	OCTAROON NO. 1	144	368			SEC14-T14N-R10W
AMC 063178	RED MT. COPPER NO 1	358	215			SEC14-T14N-R10W
AMC 063179	RED MT. COPPER NO 2	358	216			SEC14-T14N-R10W
AMC 063180	RED MT. COPPER NO 3	358	217			SEC14-T14N-R10W
AMC 063181	RED MT. COPPER NO 4	358	218			SEC14-T14N-R10W
AMC 063182	RED MT. COPPER NO 5	358	219			SEC14-T14N-R10W
AMC 063183	RED MT. COPPER NO 6	358	220			SEC14-T14N-R10W
AMC 063184	RED MT. COPPER NO 7	358	221			SEC14-T14N-R10W
AMC 063185	RED MT. COPPER NO 8	358	222			SEC14-T14N-R10W
AMC 063186	RED MT. COPPER NO 9	358	223			SEC23-T14N-R10W
AMC 063187	COPPER-RIDGE NO 1	358	206			SEC14-T14N-R10W
AMC 063188	COPPER-RIDGE NO 2	358	207			SEC14-T14N-R10W
AMC 063189	COPPER-RIDGE NO 3	358	208			SEC15-T14N-R10W
AMC 063190	COPPER RIDGE NO 4	358	209			SEC15-T14N-R10W
AMC 063191	COPPER RIDGE NO 5	358	210			SEC14-T14N-R10W
AMC 063192	COPPER RIDGE NO 6	358	211			SEC15-T14N-R10W
AMC 063193	COPPER RIDGE NO 7	358	212			SEC22-T14N-R10W
AMC 063194	COPPER RIDGE NO 8	358	213			SEC22-T14N-R10W
AMC 063195	COPPER RIDGE NO 9	358	214			SEC22-T14N-R10W
AMC 063196	ISO #1	563	346			SEC14-T14N-R10W
AMC 063197	ISO #2	563	347			SEC15-T14N-R10W
AMC 063198	ISO #3	563	348			SEC15-T14N-R10W
AMC 063199	ISO #4	563	349			SEC15-T14N-R10W

Date: 10/30/2017

RECEIVED
 AUG 19 9 15 AM '17
 PHOENIX, ARIZONA

EXHIBIT A

County: Yavapai

State: AZ

BLM Serial #	Claim Name	Original Recording		Amended Recording		Location
		Recording #	Page #	Recording #	Page #	
AMC 063200	ISO #5	563	350			SEC15-T14N-R10W
AMC 063201	ISO #6	563	351			SEC15-T14N-R10W
AMC 063202	ISO #7	563	352			SEC23-T14N-R10W
AMC 063203	ISO #8	563	353			SEC23-T14N-R10W
AMC 063204	ISO #9	563	354			SEC23-T14N-R10W
AMC 063205	ISO #10	563	355			SEC22-T14N-R10W
AMC 063206	ISO #11	563	356			SEC22-T14N-R10W
AMC 063207	ISO #12	563	357			SEC22-T14N-R10W
AMC 063208	ISO #13	563	358			SEC15-T14N-R10W
AMC 063209	ISO #14	563	359			SEC22-T14N-R10W
AMC 063210	ISO #15	568	502			SEC15-T14N-R10W
AMC 063211	ISO #16	568	503			SEC15-T14N-R10W
AMC 079981	R & R #1	608	344			SEC19-T14N-R09W
AMC 079982	R & R #3	608	346			SEC18-T14N-R09W
AMC 079983	R & R #4	608	347			SEC19-T14N-R09W
AMC 079984	BRUCE #2	608	349			SEC19-T14N-R09W
AMC 079985	JOS #1	576	125			SEC19-T14N-R09W
AMC 079986	JOS #2	576	126			SEC19-T14N-R09W
AMC 079987	JOS #3	576	127	761	181	SEC19-T14N-R09W
AMC 079988	JOS #4	576	128			SEC19-T14N-R09W
AMC 079989	COMBINE NO. 2	511	463			SEC18-T14N-R09W
AMC 079990	L. & W. NO. 1	015	228			SEC19-T14N-R09W
AMC 079991	L. & W. NO. 2	015	229			SEC19-T14N-R09W
AMC 079992	L. & W. NO. 6	015	233			SEC19-T14N-R09W
AMC 079993	L. & W. FRACTION	015	226	761	182	SEC19-T14N-R09W
AMC 079994	POSSIBILITIES NO. 1	015	225			SEC19-T14N-R09W
AMC 159967	BM 1	1441	332			SEC09-T14N-R09W
AMC 159968	BM 2	1441	334			SEC09-T14N-R09W
AMC 305766	BEV 1	2265	277			SEC09-T14N-R09W
AMC 305767	BEV 2	2265	279			SEC09-T14N-R09W
AMC 305768	BEV 3	2265	281			SEC09-T14N-R09W
AMC 305769	BEV 4	2265	283			SEC09-T14N-R09W
AMC 305770	BEV 5	2265	285			SEC09-T14N-R09W
AMC 305771	BEV 6	2265	287			SEC09-T14N-R09W
AMC 305772	BEV 7	2265	289			SEC09-T14N-R09W
AMC 305773	BEV 8	2265	291			SEC09-T14N-R09W
AMC 305774	BEV 9	2265	293			SEC09-T14N-R09W
AMC 305775	BEV 10	2265	295			SEC09-T14N-R09W

RECEIVED
 CLM AZ STATE OFFICE
 2017 JUL -9 A 9:55
 PHOENIX ARIZONA

EXHIBIT A

County: Yavapai

State: AZ

<u>BLM Serial #</u>	<u>Claim Name</u>	<u>Original Recording</u>		<u>Amended Recording</u>		<u>Location</u>
		<u>Recording #</u>	<u>Page #</u>	<u>Recording #</u>	<u>Page #</u>	
AMC 305776	BEV 11	2265	297			SEC09-T14N-R09W
AMC 305777	BEV 12	2265	299			SEC09-T14N-R09W
AMC 305778	BEV 13	2265	301			SEC09-T14N-R09W
AMC 305779	BEV 14	2265	303			SEC09-T14N-R09W
AMC 305780	BEV 15	2265	305			SEC09-T14N-R09W
AMC 305781	BEV 16	2265	307			SEC09-T14N-R09W
AMC 305782	BEV 17	2265	309			SEC09-T14N-R09W
AMC 305783	BEV 18	2265	311			SEC09-T14N-R09W
AMC 305784	BEV 19	2265	313			SEC09-T14N-R09W
AMC 305785	BEV 20	2265	315			SEC09-T14N-R09W
AMC 305786	BEV 21	2265	317			SEC09-T14N-R09W
AMC 305787	BEV 22	2265	319			SEC09-T14N-R09W
AMC 305788	BEV 23	2265	321			SEC09-T14N-R09W
AMC 305789	BEV 24	2265	323			SEC09-T14N-R09W
AMC 305790	BEV 25	2265	325			SEC09-T14N-R09W
AMC 305791	BEV 26	2265	327			SEC09-T14N-R09W
AMC 305792	BEV 27	2265	329			SEC09-T14N-R09W
AMC 305793	BEV 28	2265	331			SEC09-T14N-R09W
AMC 305794	BEV 29	2265	333			SEC09-T14N-R09W
AMC 305795	BEV 30	2265	335			SEC09-T14N-R09W
AMC 305796	BEV 31	2265	337			SEC09-T14N-R09W
AMC 305797	BEV 32	2265	339			SEC09-T14N-R09W
AMC 305798	BEV 33	2265	341			SEC09-T14N-R09W
AMC 305799	BEV 34	2265	343			SEC09-T14N-R09W
AMC 305800	BEV 35	2265	345			SEC09-T14N-R09W
AMC 305801	BEV 36	2265	347			SEC09-T14N-R09W
AMC 305802	BEV 37	2265	349			SEC09-T14N-R09W
AMC 305803	BEV 38	2265	351			SEC09-T14N-R09W
AMC 305804	BEV 39	2265	353			SEC09-T14N-R09W
AMC 305805	BEV 40	2265	355			SEC09-T14N-R09W
AMC 305806	BEV 41	2265	357			SEC09-T14N-R09W
AMC 305807	BEV 42	2265	359			SEC09-T14N-R09W
AMC 305808	BEV 43	2265	361			SEC09-T14N-R09W
AMC 305809	BEV 44	2265	363			SEC09-T14N-R09W
AMC 305810	BEV 45	2265	365			SEC09-T14N-R09W
AMC 305811	BEV 46	2265	367			SEC09-T14N-R09W
AMC 305812	BEV 47	2265	369			SEC09-T14N-R09W
AMC 305813	BEV 48	2265	371			SEC09-T14N-R09W

RECEIVED
 DATE OF RECORDING
 2018 AUG -9 A 9:59
 PHOENIX ARIZONA

EXHIBIT A

County: Yavapai

State: AZ

BLM Serial #	Claim Name	Original Recording		Amended Recording		Location
		Recording #	Page #	Recording #	Page #	
AMC 305814	BEV 49	2265	373			SEC09-T14N-R09W
AMC 305815	BEV 50	2265	375			SEC09-T14N-R09W
AMC 305816	BEV 51	2265	377			SEC09-T14N-R09W
AMC 305817	BEV 52	2265	379			SEC09-T14N-R09W
AMC 305818	BEV 53	2265	381			SEC09-T14N-R09W
AMC 305819	BEV 54	2265	383			SEC09-T14N-R09W
AMC 308466	FSM #1	2297	161			SEC20-T14N-R09W
AMC 308467	FSM #2	2297	163			SEC20-T14N-R09W
AMC 308468	FSM #3	2297	165			SEC20-T14N-R09W
AMC 308469	FSM #4	2297	167			SEC20-T14N-R09W
AMC 308470	FSM #5	2297	169			SEC20-T14N-R09W
AMC 308471	FSM #6	2297	171			SEC20-T14N-R09W
AMC 308472	FSM #7	2297	173			SEC20-T14N-R09W
AMC 308473	JWH #1	2297	105			SEC07-T14N-R09W
AMC 308474	JWH #2	2297	107			SEC07-T14N-R09W
AMC 308475	JWH #3	2297	109			SEC07-T14N-R09W
AMC 308476	JWH #4	2297	111			SEC07-T14N-R09W
AMC 308477	JWH #5	2297	113			SEC07-T14N-R09W
AMC 308478	JWH #6	2297	115			SEC07-T14N-R09W
AMC 308479	JWH #7	2297	117			SEC07-T14N-R09W
AMC 308480	JWH #8	2297	119			SEC07-T14N-R09W
AMC 308481	JWH #9	2297	121			SEC07-T14N-R09W
AMC 308482	JWH #10	2297	123			SEC07-T14N-R09W
AMC 308483	JWH #11	2297	125			SEC07-T14N-R09W
AMC 308484	JWH #12	2297	127			SEC07-T14N-R09W
AMC 308485	JWH #13	2297	129			SEC07-T14N-R09W
AMC 308486	JWH #14	2297	131			SEC07-T14N-R09W
AMC 308487	JWH #15	2297	133			SEC07-T14N-R09W
AMC 308488	JWH #16	2297	135			SEC07-T14N-R09W
AMC 308489	JWH #17	2297	137			SEC07-T14N-R09W
AMC 308490	JWH #18	2297	139			SEC07-T14N-R09W
AMC 308491	JWH #19	2297	141			SEC07-T14N-R09W
AMC 308492	JWH #20	2297	143			SEC07-T14N-R09W
AMC 308493	JWH #21	2297	145			SEC18-T14N-R09W
AMC 308494	JWH #22	2297	147			SEC18-T14N-R09W
AMC 308495	JWH #23	2297	149			SEC18-T14N-R09W
AMC 308496	JWH #24	2297	151			SEC18-T14N-R09W
AMC 308497	JWH #25	2297	153			SEC18-T14N-R09W

Date: 10/30/2017

RECEIVED
 PHOENIX
 AUG 9 9 58 AM '17
 ARIZONA
 STATE OFFICE

EXHIBIT A

County: Yavapai

State: AZ

BLM Serial #	Claim Name	Original Recording		Amended Recording		Location
		Recording #	Page #	Recording #	Page #	
AMC 308498	JWH #26	2297	155			SEC18-T14N-R09W
AMC 308499	JWH #27	2297	157			SEC18-T14N-R09W
AMC 308500	JWH #28	2297	159			SEC18-T14N-R09W
AMC 308501	JWH #29	2298	320			SEC13-T14N-R10W
AMC 308502	JWH #30	2298	322			SEC13-T14N-R10W
AMC 308503	JWH #31	2298	324			SEC18-T14N-R09W
AMC 308504	JWH #32	2298	326			SEC18-T14N-R09W
AMC 308505	JWH #33	2298	328			SEC18-T14N-R09W
AMC 308506	JWH #34	2298	330			SEC18-T14N-R09W
AMC 308507	JWH #35	2298	332			SEC18-T14N-R09W
AMC 308508	JWH #36	2298	334			SEC18-T14N-R09W
AMC 308509	JWH #37	2298	336			SEC18-T14N-R09W
AMC 308510	JWH #38	2298	338			SEC13-T14N-R10W
AMC 308511	JWH #39	2298	340			SEC13-T14N-R10W
AMC 308512	JWH #40	2298	342			SEC13-T14N-R10W
AMC 308513	JWH #41	2298	344			SEC18-T14N-R09W
AMC 308514	JWH #42	2298	346			SEC18-T14N-R09W
AMC 308515	JWH #43	2298	348			SEC18-T14N-R09W
AMC 308516	JWH #44	2298	350			SEC18-T14N-R09W
AMC 308517	JWH #45	2298	352			SEC18-T14N-R09W
AMC 308518	JWH #46	2298	354			SEC18-T14N-R09W
AMC 308519	JWH #47	2298	356			SEC18-T14N-R09W
AMC 308520	JWH #48	2298	358			SEC18-T14N-R09W
AMC 308521	JWH #49	2298	360			SEC13-T14N-R10W
AMC 308522	JWH #50	2298	362			SEC13-T14N-R10W
AMC 308523	JWH #51	2298	364			SEC18-T14N-R09W
AMC 308524	JWH #52	2298	366			SEC18-T14N-R09W
AMC 308525	JWH #53	2298	368			SEC18-T14N-R09W
AMC 308526	JWH #54	2298	370			SEC18-T14N-R09W
AMC 308527	JWH #55	2298	372			SEC18-T14N-R09W
AMC 308528	JWH #56	2298	374			SEC18-T14N-R09W
AMC 308529	JWH #57	2298	376			SEC18-T14N-R09W
AMC 308530	JWH #58	2298	378			SEC18-T14N-R09W
AMC 308531	JWH #59	2298	380			SEC18-T14N-R09W
AMC 308532	JWH #60	2298	382			SEC19-T14N-R09W
AMC 308533	JWH #61	2298	384			SEC19-T14N-R09W
AMC 308534	JWH #62	2298	386			SEC19-T14N-R09W
AMC 308535	JWH #63	2298	388			SEC19-T14N-R09W

RECEIVED
 2018 AUG -9 A 9:55
 PIM AZ STATE OFFICE
 OF LAND MANAGEMENT
 CARSONA

EXHIBIT A

County: Yavapai

State: AZ

BLM Serial #	Claim Name	Original Recording		Amended Recording		Location
		Recording #	Page #	Recording #	Page #	
AMC 308536	JWH #64	2298	390			SEC19-T14N-R09W
AMC 308537	JWH #65	2298	392			SEC19-T14N-R09W
AMC 308538	JWH #66	2298	394			SEC19-T14N-R09W
AMC 308539	JWH #67	2298	396			SEC19-T14N-R09W
AMC 308540	JWH #68	2298	398			SEC19-T14N-R09W
AMC 308541	JWH #69	2298	400			SEC24-T14N-R10W
AMC 308542	JWH #70	2298	402			SEC24-T14N-R10W
AMC 308543	JWH #71	2298	404			SEC24-T14N-R10W
AMC 308544	JWH #72	2298	406			SEC24-T14N-R10W
AMC 308545	JWH #73	2298	408			SEC24-T14N-R10W
AMC 308546	JWH #74	2298	410			SEC24-T14N-R10W
AMC 308547	JWH #75	2298	412			SEC24-T14N-R10W
AMC 308548	JWH #76	2298	414			SEC24-T14N-R10W
AMC 308549	JWH #77	2298	416			SEC24-T14N-R10W
AMC 317120	LAW 1	2407	887			SEC28-T15N-R10W
AMC 317121	LAW 2	2407	889			SEC28-T15N-R10W
AMC 317122	LAW 3	2407	891			SEC28-T15N-R10W
AMC 317123	LAW 4	2407	893			SEC28-T15N-R10W
AMC 317124	LAW 5	2407	895			SEC33-T15N-R10W
AMC 317125	LAW 6	2407	897			SEC33-T15N-R10W
AMC 317126	LAW 7	2407	899			SEC33-T15N-R10W
AMC 317127	LAW 8	2407	901			SEC33-T15N-R10W
AMC 317128	LAW 9	2407	903			SEC33-T15N-R10W
AMC 317129	LAW 10	2407	905			SEC33-T15N-R10W
AMC 317130	LAW 11	2407	907			SEC33-T15N-R10W
AMC 317131	LAW 12	2407	909			SEC33-T15N-R10W
AMC 317132	LAW 13	2407	911			SEC28-T15N-R10W
AMC 317133	LAW 14	2407	913			SEC28-T15N-R10W
AMC 317134	LAW 15	2407	915			SEC28-T15N-R10W
AMC 317135	LAW 16	2407	917			SEC28-T15N-R10W
AMC 317136	LAW 17	2407	919			SEC33-T15N-R10W
AMC 317137	LAW 18	2407	921			SEC33-T15N-R10W
AMC 317138	LAW 19	2407	923			SEC33-T15N-R10W
AMC 317139	LAW 20	2407	925			SEC33-T15N-R10W
AMC 317140	LAW 21	2407	927			SEC33-T15N-R10W
AMC 317141	LAW 22	2407	929			SEC33-T15N-R10W
AMC 317142	LAW 23	2407	931			SEC33-T15N-R10W
AMC 317143	LAW 24	2407	933			SEC33-T15N-R10W

RECEIVED
 PHOENIX
 ARIZONA
 210 AUG 19 9 51 AM '17

EXHIBIT A

County: Yavapai

State: AZ

<u>BLM Serial #</u>	<u>Claim Name</u>	<u>Original Recording</u>		<u>Amended Recording</u>		<u>Location</u>
		<u>Recording #</u>	<u>Page #</u>	<u>Recording #</u>	<u>Page #</u>	
AMC 317144	LAW 25	2407	934			SEC28-T15N-R10W
AMC 317145	LAW 26	2407	936			SEC28-T15N-R10W
AMC 317146	LAW 27	2407	938			SEC28-T15N-R10W
AMC 317147	LAW 28	2407	940			SEC28-T15N-R10W
AMC 317148	LAW 29	2407	942			SEC28-T15N-R10W
AMC 317149	LAW 30	2407	943			SEC28-T15N-R10W
AMC 317150	LAW 31	2407	945			SEC28-T15N-R10W
AMC 317151	LAW 32	2407	947			SEC28-T15N-R10W
AMC 317152	LAW 33	2407	949			SEC33-T15N-R10W
AMC 317153	LAW 34	2407	951			SEC33-T15N-R10W
AMC 317154	LAW 35	2407	953			SEC33-T15N-R10W
AMC 317155	LAW 36	2407	955			SEC33-T15N-R10W
AMC 317156	LAW 37	2407	957			SEC33-T15N-R10W
AMC 317157	LAW 38	2407	959			SEC33-T15N-R10W
AMC 317158	LAW 39	2407	961			SEC33-T15N-R10W
AMC 317159	LAW 40	2407	963			SEC33-T15N-R10W
AMC 317160	LAW 41	2407	965			SEC28-T15N-R10W
AMC 317161	LAW 42	2407	967			SEC28-T15N-R10W
AMC 317162	LAW 43	2407	969			SEC28-T15N-R10W
AMC 317163	LAW 44	2407	971			SEC28-T15N-R10W
AMC 317164	LAW 45	2407	973			SEC28-T15N-R10W
AMC 317165	LAW 46	2407	975			SEC28-T15N-R10W
AMC 317166	LAW 47	2407	977			SEC28-T15N-R10W
AMC 317167	LAW 48	2407	979			SEC28-T15N-R10W
AMC 317168	LAW 49	2407	981			SEC33-T15N-R10W
AMC 317169	LAW 50	2407	983			SEC33-T15N-R10W
AMC 317170	LAW 51	2407	985			SEC33-T15N-R10W
AMC 317171	LAW 52	2407	987			SEC33-T15N-R10W
AMC 317172	LAW 53	2407	989			SEC33-T15N-R10W
AMC 317173	LAW 54	2407	991			SEC33-T15N-R10W
AMC 317174	LAW 55	2407	993			SEC33-T15N-R10W
AMC 317175	LAW 56	2407	995			SEC33-T15N-R10W
AMC 317176	LAW 57	2407	997			SEC28-T15N-R10W
AMC 317177	LAW 58	2407	999			SEC28-T15N-R10W
AMC 317178	LAW 59	2408	1			SEC28-T15N-R10W
AMC 317179	LAW 60	2408	3			SEC28-T15N-R10W
AMC 317180	LAW 61	2408	5			SEC28-T15N-R10W
AMC 317181	LAW 62	2408	7			SEC28-T15N-R10W

RECEIVED
 ARIZONA
 STATE OFFICE
 700 N. 1ST AVENUE
 PHOENIX, ARIZONA

EXHIBIT A

County: Yavapai

State: AZ

<u>BLM Serial #</u>	<u>Claim Name</u>	<u>Original Recording</u>		<u>Amended Recording</u>		<u>Location</u>
		<u>Recording #</u>	<u>Page #</u>	<u>Recording #</u>	<u>Page #</u>	
AMC 317182	LAW 63	2408	9			SEC28-T15N-R10W
AMC 317183	LAW 64	2408	11			SEC28-T15N-R10W
AMC 317184	LAW 65	2408	13			SEC33-T15N-R10W
AMC 317185	LAW 66	2408	15			SEC33-T15N-R10W
AMC 317186	LAW 67	2408	17			SEC33-T15N-R10W
AMC 317187	LAW 68	2408	19			SEC33-T15N-R10W
AMC 317188	LAW 69	2408	21			SEC33-T15N-R10W
AMC 317189	LAW 70	2408	23			SEC33-T15N-R10W
AMC 317190	LAW 71	2408	25			SEC33-T15N-R10W
AMC 317191	LAW 72	2408	27			SEC33-T15N-R10W
AMC 317192	LAW 73	2408	29			SEC28-T15N-R10W
AMC 317193	LAW 74	2408	31			SEC28-T15N-R10W
AMC 317194	LAW 75	2408	33			SEC28-T15N-R10W
AMC 317195	LAW 76	2408	35			SEC28-T15N-R10W
AMC 317196	LAW 77	2408	37			SEC28-T15N-R10W
AMC 317197	LAW 78	2408	39			SEC28-T15N-R10W
AMC 317198	LAW 79	2408	41			SEC28-T15N-R10W
AMC 317199	LAW 80	2408	43			SEC28-T15N-R10W
AMC 317200	LAW 81	2408	45			SEC33-T15N-R10W
AMC 317201	LAW 82	2408	47			SEC33-T15N-R10W
AMC 317202	LAW 83	2408	49			SEC33-T15N-R10W
AMC 317203	LAW 84	2408	51			SEC28-T15N-R10W
AMC 317204	LAW 85	2408	53			SEC28-T15N-R10W
AMC 317205	LAW 86	2408	55			SEC33-T15N-R10W
AMC 317206	LAW 87	2408	57			SEC28-T15N-R10W
AMC 317207	LAW 88	2408	59			SEC33-T15N-R10W
AMC 317208	LAW 89	2408	61			SEC28-T15N-R10W
AMC 317209	LAW 90	2408	63			SEC28-T15N-R10W
AMC 317210	LAW 91	2408	65			SEC28-T15N-R10W
AMC 317211	LAW 92	2408	67			SEC28-T15N-R10W
AMC 317212	LAW 93	2408	69			SEC28-T15N-R10W
AMC 317213	LAW 94	2408	71			SEC28-T15N-R10W
AMC 317214	LAW 95	2408	73			SEC28-T15N-R10W
AMC 317215	LAW 96	2408	75			SEC28-T15N-R10W
AMC 317216	LAW 97	2408	77			SEC33-T15N-R10W
AMC 317217	LAW 98	2408	79			SEC33-T15N-R10W
AMC 317218	LAW 99	2408	81			SEC33-T15N-R10W
AMC 317219	LAW 100	2408	83			SEC33-T15N-R10W

RECEIVED
 DEPT. OF FIC
 2018 AUG - 9 A 9:57
 PHOENIX, ARIZONA

EXHIBIT A

County: Yavapai

State: AZ

<u>BLM Serial #</u>	<u>Claim Name</u>	<u>Original Recording</u>		<u>Amended Recording</u>		<u>Location</u>
		<u>Recording #</u>	<u>Page #</u>	<u>Recording #</u>	<u>Page #</u>	
AMC 317220	LAW 101	2408	85			SEC33-T15N-R10W
AMC 317221	LAW 102	2408	87			SEC33-T15N-R10W
AMC 317222	LAW 103	2408	89			SEC33-T15N-R10W
AMC 317223	LAW 104	2408	91			SEC33-T15N-R10W
AMC 317224	LAW 105	2408	93			SEC28-T15N-R10W
AMC 317225	LAW 106	2408	95			SEC28-T15N-R10W
AMC 317226	LAW 107	2408	97			SEC28-T15N-R10W
AMC 317227	LAW 108	2408	99			SEC28-T15N-R10W
AMC 317228	LAW 109	2408	101			SEC28-T15N-R10W
AMC 317229	LAW 110	2408	103			SEC28-T15N-R10W
AMC 317230	LAW 111	2408	105			SEC28-T15N-R10W
AMC 317231	LAW 112	2408	107			SEC28-T15N-R10W
AMC 317232	LAW 113	2408	109			SEC33-T15N-R10W
AMC 317233	LAW 114	2408	111			SEC33-T15N-R10W
AMC 317234	LAW 115	2408	113			SEC33-T15N-R10W
AMC 317235	LAW 116	2408	115			SEC33-T15N-R10W
AMC 317236	LAW 117	2408	117			SEC33-T15N-R10W
AMC 317237	LAW 118	2408	119			SEC33-T15N-R10W
AMC 317238	LAW 119	2408	121			SEC33-T15N-R10W
AMC 317239	LAW 120	2408	123			SEC33-T15N-R10W
AMC 317240	LAW 121	2408	125			SEC27-T15N-R10W
AMC 317241	LAW 122	2408	127			SEC27-T15N-R10W
AMC 317242	LAW 123	2408	129			SEC27-T15N-R10W
AMC 317243	LAW 124	2408	131			SEC27-T15N-R10W
AMC 317244	LAW 125	2408	133			SEC27-T15N-R10W
AMC 317245	LAW 126	2408	135			SEC27-T15N-R10W
AMC 317246	LAW 127	2408	137			SEC27-T15N-R10W
AMC 317247	LAW 128	2408	139			SEC27-T15N-R10W
AMC 317248	LAW 129	2408	141			SEC34-T15N-R10W
AMC 317249	LAW 130	2408	143			SEC34-T15N-R10W
AMC 317250	LAW 131	2408	145			SEC34-T15N-R10W
AMC 317251	LAW 132	2408	147			SEC34-T15N-R10W
AMC 317252	LAW 133	2408	149			SEC34-T15N-R10W
AMC 317253	LAW 134	2408	151			SEC34-T15N-R10W
AMC 317254	LAW 135	2408	153			SEC34-T15N-R10W
AMC 317255	LAW 136	2408	155			SEC34-T15N-R10W
AMC 317256	LAW 137	2408	157			SEC34-T15N-R10W
AMC 317257	LAW 138	2408	159			SEC34-T15N-R10W

RECEIVED
 P. M. AZ STATE OFFICE
 PHOENIX ARIZONA
 2018 AUG -9 A 0551

EXHIBIT A

County: Yavapai

State: AZ

<u>BLM Serial #</u>	<u>Claim Name</u>	<u>Original Recording</u>		<u>Amended Recording</u>		<u>Location</u>
		<u>Recording #</u>	<u>Page #</u>	<u>Recording #</u>	<u>Page #</u>	
AMC 317258	LAW 139	2408	161			SEC34-T15N-R10W
AMC 317259	LAW 140	2408	163			SEC34-T15N-R10W
AMC 317260	LAW 141	2408	165			SEC34-T15N-R10W
AMC 317261	LAW 142	2408	167			SEC34-T15N-R10W
AMC 317262	LAW 143	2408	169			SEC34-T15N-R10W
AMC 317263	LAW 144	2408	171			SEC34-T15N-R10W
AMC 317268	LAW 149	2408	181			SEC34-T15N-R10W
AMC 317269	LAW 150	2408	183			SEC34-T15N-R10W
AMC 317270	LAW 151	2408	185			SEC34-T15N-R10W
AMC 317271	LAW 152	2408	187			SEC34-T15N-R10W
AMC 317276	LAW 157	2408	197			SEC34-T15N-R10W
AMC 317277	LAW 158	2408	199			SEC34-T15N-R10W
AMC 317278	LAW 159	2408	201			SEC34-T15N-R10W
AMC 317279	LAW 160	2408	203			SEC34-T15N-R10W
AMC 317284	LAW 165	2408	213			SEC35-T15N-R10W
AMC 317285	LAW 166	2408	215			SEC35-T15N-R10W
AMC 317286	LAW 167	2408	217			SEC35-T15N-R10W
AMC 317287	LAW 168	2408	219			SEC35-T15N-R10W
AMC 317292	LAW 173	2408	229			SEC35-T15N-R10W
AMC 317293	LAW 174	2408	231			SEC35-T15N-R10W
AMC 317294	LAW 175	2408	233			SEC35-T15N-R10W
AMC 317295	LAW 176	2408	235			SEC35-T15N-R10W
AMC 317296	LAW 177	2408	237			SEC35-T15N-R10W
AMC 317297	LAW 178	2408	239			SEC35-T15N-R10W
AMC 317298	LAW 179	2408	241			SEC35-T15N-R10W
AMC 317299	LAW 180	2408	243			SEC35-T15N-R10W
AMC 317300	LAW 181	2408	245			SEC35-T15N-R10W
AMC 317301	LAW 182	2408	247			SEC35-T15N-R10W
AMC 317302	LAW 183	2408	249			SEC35-T15N-R10W
AMC 317303	LAW 184	2408	251			SEC35-T15N-R10W
AMC 317304	LAW 185	2408	253			SEC35-T15N-R10W
AMC 317305	LAW 186	2408	255			SEC35-T15N-R10W
AMC 317306	LAW 187	2408	257			SEC35-T15N-R10W
AMC 317307	LAW 188	2408	259			SEC35-T15N-R10W
AMC 317308	LAW 189	2408	261			SEC35-T15N-R10W
AMC 317309	LAW 190	2408	263			SEC35-T15N-R10W
AMC 317310	LAW 191	2408	265			SEC35-T15N-R10W
AMC 317311	LAW 192	2408	267			SEC35-T15N-R10W

RECEIVED
 MAY 27 2016
 PHOENIX, ARIZONA
 COUNTY CLERK'S OFFICE

EXHIBIT A

County: Yavapai

State: AZ

<u>BLM Serial #</u>	<u>Claim Name</u>	<u>Original Recording</u>		<u>Amended Recording</u>		<u>Location</u>
		<u>Recording #</u>	<u>Page #</u>	<u>Recording #</u>	<u>Page #</u>	
AMC 317312	LAW 193	2408	269			SEC26-T15N-R10W
AMC 317313	LAW 194	2408	271			SEC26-T15N-R10W
AMC 317314	LAW 195	2408	273			SEC26-T15N-R10W
AMC 317315	LAW 196	2408	275			SEC26-T15N-R10W
AMC 317316	LAW 197	2408	277			SEC35-T15N-R10W
AMC 317317	LAW 198	2408	279			SEC35-T15N-R10W
AMC 317318	LAW 199	2408	281			SEC35-T15N-R10W
AMC 317319	LAW 200	2408	283			SEC35-T15N-R10W
AMC 317320	LAW 201	2408	285			SEC35-T15N-R10W
AMC 317321	LAW 202	2408	287			SEC35-T15N-R10W
AMC 317322	LAW 203	2408	289			SEC35-T15N-R10W
AMC 317323	LAW 204	2408	291			SEC35-T15N-R10W
AMC 317324	LAW 205	2408	293			SEC26-T15N-R10W
AMC 317325	LAW 206	2408	295			SEC26-T15N-R10W
AMC 317326	LAW 207	2408	297			SEC26-T15N-R10W
AMC 317327	LAW 208	2408	299			SEC35-T15N-R10W
AMC 317328	LAW 209	2408	301			SEC35-T15N-R10W
AMC 317329	LAW 210	2408	303			SEC35-T15N-R10W
AMC 317330	LAW 211	2408	305			SEC35-T15N-R10W
AMC 317331	LAW 212	2408	307			SEC35-T15N-R10W
AMC 317332	LAW 213	2408	309			SEC35-T15N-R10W
AMC 317333	LAW 214	2408	311			SEC35-T15N-R10W
AMC 317334	LAW 215	2408	313			SEC35-T15N-R10W
AMC 317335	LAW 216	2408	315			SEC26-T15N-R10W
AMC 317336	LAW 217	2408	317			SEC26-T15N-R10W
AMC 317337	LAW 218	2408	319			SEC26-T15N-R10W
AMC 317338	LAW 219	2408	321			SEC26-T15N-R10W
AMC 317339	LAW 220	2408	323			SEC35-T15N-R10W
AMC 317340	LAW 221	2408	325			SEC35-T15N-R10W
AMC 317341	LAW 222	2408	327			SEC35-T15N-R10W
AMC 317342	LAW 223	2408	329			SEC35-T15N-R10W
AMC 317343	LAW 224	2408	331			SEC35-T15N-R10W
AMC 317344	LAW 225	2408	333			SEC35-T15N-R10W
AMC 317345	LAW 226	2408	335			SEC35-T15N-R10W
AMC 317346	LAW 227	2408	337			SEC35-T15N-R10W
AMC 317347	LAW 228	2408	339			SEC26-T15N-R10W
AMC 317348	LAW 229	2408	341			SEC26-T15N-R10W
AMC 317349	LAW 230	2408	343			SEC26-T15N-R10W

RECEIVED
 2018 AUG -9 A 9 57
 PHOENIX ARIZONA
 11M AZ STATE OFFICE

EXHIBIT A

County: Yavapai

State: AZ

BLM Serial #	Claim Name	Original Recording		Amended Recording		Location
		Recording #	Page #	Recording #	Page #	
AMC 317350	LAW 231	2408	345			SEC26-T15N-R10W
AMC 317351	LAW 232	2408	347			SEC26-T15N-R10W
AMC 317352	LAW 233	2408	349			SEC35-T15N-R10W
AMC 317353	LAW 234	2408	351			SEC35-T15N-R10W
AMC 317354	LAW 235	2408	353			SEC35-T15N-R10W
AMC 317355	LAW 236	2408	355			SEC35-T15N-R10W
AMC 317356	LAW 237	2408	357			SEC35-T15N-R10W
AMC 317357	LAW 238	2408	359			SEC35-T15N-R10W
AMC 317358	LAW 239	2408	361			SEC35-T15N-R10W
AMC 317359	LAW 240	2408	363			SEC35-T15N-R10W
AMC 322631	JWH 80	2494	611			SEC07-T14N-R09W
AMC 322632	JWH 81	2494	613			SEC07-T14N-R09W
AMC 322633	JWH 82	2494	615			SEC07-T14N-R09W
AMC 322634	JWH 83	2494	617			SEC07-T14N-R09W
AMC 362070	KIM-1	4166	88			SEC09-T14N-R09W
AMC 362071	KIM-2	4166	89			SEC09-T14N-R09W
AMC 362072	KIM-3	4166	90			SEC09-T14N-R09W
AMC 362073	KIM-4	4166	91			SEC09-T14N-R09W
AMC 362074	KIM-5	4166	92			SEC09-T14N-R09W
AMC 362075	KIM-6	4166	93			SEC09-T14N-R09W
AMC 362076	KIM-7	4166	94			SEC09-T14N-R09W
AMC 362077	KIM-8	4166	95			SEC09-T14N-R09W
AMC 362078	KIM-9	4166	96			SEC09-T14N-R09W
AMC 362079	KIM-10	4166	97			SEC09-T14N-R09W
AMC 362080	KIM-11	4166	98			SEC09-T14N-R09W
AMC 362081	KIM-12	4166	99			SEC09-T14N-R09W
AMC 362082	KIM-13	4166	100			SEC09-T14N-R09W
AMC 362083	KIM-14	4166	101			SEC09-T14N-R09W
AMC 362084	KIM-15	4166	102			SEC09-T14N-R09W
AMC 362085	KIM-16	4166	103			SEC09-T14N-R09W
AMC 362086	KIM-17	4166	104			SEC08-T14N-R09W
AMC 362087	KIM-18	4166	105			SEC08-T14N-R09W
AMC 362088	KIM-19	4166	106			SEC08-T14N-R09W
AMC 362089	KIM-20	4166	107			SEC08-T14N-R09W
AMC 362090	KIM-21	4166	108			SEC08-T14N-R09W
AMC 362093	KIM-24	4166	111			SEC08-T14N-R09W
AMC 362094	KIM-25	4166	112			SEC08-T14N-R09W
AMC 362095	KIM-26	4166	113			SEC08-T14N-R09W

RECEIVED
 DEPT. OF LAND AND WATER
 STATE OF ARIZONA
 AUG - 9 - 2017
 9:51 AM

EXHIBIT A

County: Yavapai

State: AZ

<u>BLM Serial #</u>	<u>Claim Name</u>	<u>Original Recording</u>		<u>Amended Recording</u>		<u>Location</u>
		<u>Recording #</u>	<u>Page #</u>	<u>Recording #</u>	<u>Page #</u>	
AMC 362096 7	KIM-27	4166	114			SEC08-T14N-R09W
AMC 362097 J	KIM-28	4166	115			SEC08-T14N-R09W
AMC 362100 7	KIM-31	4166	118			SEC09-T14N-R09W
AMC 362101	KIM-32	4166	119			SEC09-T14N-R09W
AMC 362102 J	KIM-33	4166	120			SEC09-T14N-R09W
AMC 364582 7	WP-1	4214	518			SEC08-T14N-R09W
AMC 364583	WP-2	4214	519			SEC08-T14N-R09W
AMC 364584	WP-3	4214	520			SEC08-T14N-R09W
AMC 364585	WP-4	4214	521			SEC08-T14N-R09W
AMC 364586	WP-5	4214	522			SEC08-T14N-R09W
AMC 364587	WP-6	4214	523			SEC08-T14N-R09W
AMC 364588 J	WP-7	4214	524			SEC08-T14N-R09W
AMC 364595 ←	WP-14	4214	531			SEC08-T14N-R09W
AMC 364597 ←	WP-16	4214	533			SEC08-T14N-R09W
AMC 366984 ←	WP-25	4302	836			SEC08-T14N-R09W
AMC 366987 ←	WP-28	4302	839			SEC08-T14N-R09W
AMC 397200 ←	LTB-7	4680	541			SEC08-T14N-R09W
AMC 397202 ←	LTB-9	4680	543			SEC08-T14N-R09W
AMC 397204 7	LTB-11	4680	545			SEC08-T14N-R09W
AMC 397205	LTB-12	4680	546			SEC08-T14N-R09W
AMC 397206	LTB-13	4680	547			SEC08-T14N-R09W
AMC 397207	LTB-14	4680	548			SEC08-T14N-R09W
AMC 397208	LTB-15	4680	549			SEC08-T14N-R09W
AMC 397209	LTB-16	4680	550			SEC08-T14N-R09W
AMC 397210 J	LTB-17	4680	551			SEC08-T14N-R09W
AMC 397214 ←	LTB-21	4680	555			SEC17-T14N-R09W
AMC 397220 ←	LTB-27	4680	561			SEC17-T14N-R09W
AMC 403441 7	PMB 1	4781	486			SEC17-T14N-R09W
AMC 403442	PMB 2	4781	487			SEC17-T14N-R09W
AMC 403443	PMB 3	4781	488			SEC17-T14N-R09W
AMC 403444	PMB 4	4781	489			SEC17-T14N-R09W
AMC 403445	PMB 5	4781	490			SEC17-T14N-R09W
AMC 403446	PMB 6	4781	491			SEC17-T14N-R09W
AMC 403447	PMB 7	4781	492			SEC17-T14N-R09W
AMC 403448 J	PMB 8	4781	493			SEC17-T14N-R09W
AMC 403450 7	PMB 10	4781	495			SEC17-T14N-R09W
AMC 403451	PMB 11	4781	496			SEC17-T14N-R09W
AMC 403452 J	PMB 12	4781	497			SEC17-T14N-R09W

Date: 10/30/2017

RECEIVED
 2016 AUG 26 9:57 AM
 SHONIA STATED FILE
 SHONIA STATED FILE
 SHONIA STATED FILE

EXHIBIT A

County: Yavapai

State: AZ

BLM Serial #	Claim Name	Original Recording		Amended Recording		Location
		Recording #	Page #	Recording #	Page #	
AMC 403453 7	PMB 13	4781	498			SEC17-T14N-R09W
AMC 403454	PMB 14	4781	499			SEC17-T14N-R09W
AMC 403455	PMB 15	4781	500			SEC17-T14N-R09W
AMC 403456	PMB 16	4781	501			SEC17-T14N-R09W
AMC 403457	PMB 17	4781	502			SEC17-T14N-R09W
AMC 403458	PMB 18	4781	503			SEC17-T14N-R09W
AMC 403459	PMB 19	4781	504			SEC17-T14N-R09W
AMC 403460	PMB 20	4781	505			SEC17-T14N-R09W
AMC 403461 } 7	PMB 21	4781	506			SEC17-T14N-R09W
AMC 403464 } 7	PMB 24	4781	509			SEC17-T14N-R09W
AMC 403465	PMB 25	4781	510			SEC17-T14N-R09W
AMC 403466	PMB 26	4781	511			SEC17-T14N-R09W
AMC 403467	PMB 27	4781	512			SEC17-T14N-R09W
AMC 403468	PMB 28	4781	513			SEC17-T14N-R09W
AMC 403469	PMB 29	4781	514			SEC17-T14N-R09W
AMC 403470	PMB 30	4781	515			SEC17-T14N-R09W
AMC 403471	PMB 31	4781	516			SEC17-T14N-R09W
AMC 403472 } 7	PMB 32	4781	517			SEC17-T14N-R09W
AMC 403477 } 7	PMB 37	4781	522			SEC17-T14N-R09W
AMC 403478	PMB 38	4781	523			SEC17-T14N-R09W
AMC 403479	PMB 39	4781	524			SEC17-T14N-R09W
AMC 403480	PMB 40	4781	525			SEC17-T14N-R09W
AMC 403481 } 7	PMB 41	4781	526			SEC17-T14N-R09W
AMC 403485 } 7	PMB 45	4781	530			SEC17-T14N-R09W
AMC 403486	PMB 46	4781	531			SEC17-T14N-R09W
AMC 403487 } 7	PMB 47	4781	532			SEC17-T14N-R09W
AMC 413793 } 7	MPC 1	4861	238			SEC16-T14N-R09W
AMC 413794	MPC 2	4861	239			SEC16-T14N-R09W
AMC 413795	MPC 3	4861	240			SEC16-T14N-R09W
AMC 413796	MPC 4	4861	241			SEC16-T14N-R09W
AMC 413797	MPC 5	4861	242			SEC16-T14N-R09W
AMC 413798	MPC 6	4861	243			SEC16-T14N-R09W
AMC 413799	MPC 7	4861	244			SEC16-T14N-R09W
AMC 413800	MPC 8	4861	245			SEC16-T14N-R09W
AMC 413801	MPC 9	4861	246			SEC16-T14N-R09W
AMC 413802	MPC 10	4861	247			SEC16-T14N-R09W
AMC 413803	MPC 11	4861	248			SEC16-T14N-R09W
AMC 413804 } 7	MPC 12	4861	249			SEC16-T14N-R09W

Date: 10/30/2017

RECEIVED
 ARIZONA STATE OFFICE
 PHOENIX, ARIZONA
 2017 OCT 31 9:51 AM

EXHIBIT A

County: Yavapai

State: AZ

<u>BLM Serial #</u>	<u>Claim Name</u>	<u>Original Recording</u>		<u>Amended Recording</u>		<u>Location</u>
		<u>Recording #</u>	<u>Page #</u>	<u>Recording #</u>	<u>Page #</u>	
AMC 413805	MPC 13	4861	250			SEC16-T14N-R09W
AMC 413806	MPC 14	4861	251			SEC16-T14N-R09W
AMC 413807	MPC 15	4861	252			SEC16-T14N-R09W
AMC 413808	MPC 16	4861	253			SEC16-T14N-R09W
AMC 413809	MPC 17	4861	254			SEC16-T14N-R09W
AMC 413810	MPC 18	4861	255			SEC16-T14N-R09W
AMC 413811	MPC 19	4861	256			SEC16-T14N-R09W
AMC 413812	MPC 20	4861	257			SEC16-T14N-R09W
AMC 413813	MPC 21	4861	258			SEC16-T14N-R09W
AMC 413814	MPC 22	4861	259			SEC16-T14N-R09W
AMC 413815	MPC 23	4861	260			SEC16-T14N-R09W
AMC 413816	MPC 24	4861	261			SEC16-T14N-R09W
AMC 413817	MPC 25	4861	262			SEC16-T14N-R09W
AMC 413818	MPC 26	4861	263			SEC16-T14N-R09W
AMC 413819	MPC 27	4861	264			SEC16-T14N-R09W
AMC 413820	MPC 28	4861	265			SEC16-T14N-R09W
AMC 413821	MPC 29	4861	266			SEC16-T14N-R09W
AMC 413822	MPC 30	4861	267			SEC16-T14N-R09W
AMC 413823	MPC 31	4861	268			SEC16-T14N-R09W
AMC 413824	MPC 32	4861	269			SEC16-T14N-R09W
AMC 413825	MPC 33	4861	270			SEC16-T14N-R09W
AMC 413826	MPC 34	4861	271			SEC16-T14N-R09W
AMC 413827	MPC 35	4861	272			SEC16-T14N-R09W
AMC 413828	MPC 36	4861	273			SEC16-T14N-R09W
AMC 413829	MPC 37	4861	274			SEC16-T14N-R09W
AMC 413830	MPC 38	4861	275			SEC16-T14N-R09W
AMC 413831	MPC 39	4861	276			SEC16-T14N-R09W
AMC 413832	MPC 40	4861	277			SEC16-T14N-R09W
AMC 413833	MPC 41	4861	278			SEC16-T14N-R09W
AMC 413834	MPC 42	4861	279			SEC16-T14N-R09W
AMC 413835	MPC 43	4861	280			SEC16-T14N-R09W
AMC 413836	MPC 44	4861	281			SEC16-T14N-R09W
AMC 413837	MPC 45	4861	282			SEC16-T14N-R09W
AMC 413838	MPC 46	4861	283			SEC16-T14N-R09W
AMC 413839	MPC 47	4861	284			SEC16-T14N-R09W
AMC 413840	MPC 48	4861	285			SEC16-T14N-R09W
AMC 413841	MPC 49	4861	286			SEC16-T14N-R09W
AMC 413842	MPC 50	4861	287			SEC16-T14N-R09W

Date: 10/30/2017

Page 18

RECEIVED
 21 MAR 2017
 STATE OFFICE
 PHOENIX ARIZONA
 1099 AUG - 9 A 09 07

EXHIBIT A

County: Yavapai

State: AZ

<u>BLM Serial #</u>	<u>Claim Name</u>	<u>Original Recording</u>		<u>Amended Recording</u>		<u>Location</u>
		<u>Recording #</u>	<u>Page #</u>	<u>Recording #</u>	<u>Page #</u>	
AMC 413843	MPC 51	4861	288			SEC16-T14N-R09W
AMC 413844	MPC 52	4861	289			SEC16-T14N-R09W
AMC 413845	MPC 53	4861	290			SEC16-T14N-R09W
AMC 413846	MPC 54	4861	291			SEC16-T14N-R09W
AMC 413847	MPC 55	4861	292			SEC16-T14N-R09W
AMC 413848	MPC 56	4861	293			SEC16-T14N-R09W
AMC 413849	MPC 57	4861	294			SEC16-T14N-R09W
AMC 413850	MPC 58	4861	295			SEC16-T14N-R09W
AMC 413851	MPC 59	4861	296			SEC16-T14N-R09W
AMC 413852	MPC 60	4861	297			SEC16-T14N-R09W
AMC 413853	MPC 61	4861	298			SEC16-T14N-R09W
AMC 413854	MPC 62	4861	299			SEC16-T14N-R09W
AMC 413855	MPC 63	4861	300			SEC16-T14N-R09W
AMC 413856	MPC 64	4861	301			SEC16-T14N-R09W
AMC 413857	MPC 65	4861	302			SEC16-T14N-R09W
AMC 413858	MPC 66	4861	303			SEC16-T14N-R09W
AMC 413859	MPC 67	4861	304			SEC16-T14N-R09W
AMC 413860	MPC 68	4861	305			SEC16-T14N-R09W
AMC 413861	MPC 69	4861	306			SEC16-T14N-R09W
AMC 413862	MPC 70	4861	307			SEC16-T14N-R09W
AMC 413863	MPC 71	4861	308			SEC16-T14N-R09W
AMC 413864	MPC 72	4861	309			SEC16-T14N-R09W
AMC 413865	MPC 73	4861	310			SEC16-T14N-R09W
AMC 413866	MPC 74	4861	311			SEC16-T14N-R09W
AMC 413867	MPC 75	4861	312			SEC16-T14N-R09W
AMC 413868	MPC 76	4861	313			SEC16-T14N-R09W
AMC 413869	MPC 77	4861	314			SEC16-T14N-R09W
AMC 413870	MPC 78	4861	315			SEC16-T14N-R09W
AMC 413871	MPC 79	4861	316			SEC16-T14N-R09W
AMC 413872	MPC 80	4861	317			SEC16-T14N-R09W
AMC 413873	MPC 81	4861	318			SEC16-T14N-R09W
AMC 413874	MPC 82	4861	319			SEC16-T14N-R09W
AMC 413875	MPC 83	4861	320			SEC16-T14N-R09W
AMC 413876	MPC 84	4861	321			SEC16-T14N-R09W
AMC 413877	MPC 85	4861	322			SEC16-T14N-R09W
AMC 413878	MPC 86	4861	323			SEC16-T14N-R09W
AMC 413879	MPC 87	4861	324			SEC16-T14N-R09W
AMC 413880	MPC 88	4861	325			SEC16-T14N-R09W

RECEIVED
 DIVISION OF FEDERAL
 RESOURCES
 PHOENIX, ARIZONA
 2018 JUN -9 A 9:51

EXHIBIT A

County: Yavapai

State: AZ

<u>BLM Serial #</u>	<u>Claim Name</u>	<u>Original Recording</u>		<u>Amended Recording</u>		<u>Location</u>
		<u>Recording #</u>	<u>Page #</u>	<u>Recording #</u>	<u>Page #</u>	
AMC 413881	MPC 89	4861	326			SEC16-T14N-R09W
AMC 413882	MPC 90	4861	327			SEC16-T14N-R09W
AMC 413883	MPC 91	4861	328			SEC16-T14N-R09W
AMC 413884	MPC 92	4861	329			SEC16-T14N-R09W
AMC 413885	MPC 93	4861	330			SEC16-T14N-R09W
AMC 413886	MPC 94	4861	331			SEC16-T14N-R09W
AMC 413887	MPC 95	4861	332			SEC16-T14N-R09W
AMC 413888	MPC 96	4861	333			SEC16-T14N-R09W
AMC 413889	MPC 97	4861	334			SEC16-T14N-R09W
AMC 413890	MPC 98	4861	335			SEC16-T14N-R09W
AMC 413891	MPC 99	4861	336			SEC16-T14N-R09W
AMC 413892	MPC 100	4861	337			SEC16-T14N-R09W
AMC 413893	MPC 101	4861	338			SEC16-T14N-R09W
AMC 413894	MPC 102	4861	339			SEC16-T14N-R09W
AMC 413895	MPC 103	4861	340			SEC16-T14N-R09W
AMC 413896	MPC 104	4861	341			SEC16-T14N-R09W
AMC 413897	MPC 105	4861	342			SEC16-T14N-R09W
AMC 413898	MPC 106	4861	343			SEC16-T14N-R09W
AMC 413899	MPC 107	4861	344			SEC16-T14N-R09W
AMC 413900	MPC 108	4861	345			SEC16-T14N-R09W
AMC 413901	MPC 109	4861	346			SEC16-T14N-R09W
AMC 413902	MPC 110	4861	347			SEC16-T14N-R09W
AMC 413903	MPC 111	4861	348			SEC16-T14N-R09W
AMC 413904	MPC 112	4861	349			SEC16-T14N-R09W
AMC 413905	MPC 113	4861	350			SEC16-T14N-R09W
AMC 413906	MPC 114	4861	351			SEC16-T14N-R09W
AMC 413907	MPC 115	4861	352			SEC16-T14N-R09W
AMC 413908	MPC 116	4861	353			SEC16-T14N-R09W
AMC 413909	MPC 117	4861	354			SEC16-T14N-R09W
AMC 413910	MPC 118	4861	355			SEC16-T14N-R09W
AMC 413911	MPC 119	4861	356			SEC16-T14N-R09W
AMC 413912	MPC 120	4861	357			SEC16-T14N-R09W
AMC 413913	MPC 121	4861	358			SEC16-T14N-R09W
AMC 413914	MPC 122	4861	359			SEC16-T14N-R09W
AMC 413915	MPC 123	4861	360			SEC16-T14N-R09W
AMC 413916	MPC 124	4861	361			SEC16-T14N-R09W
AMC 413917	MPC 125	4861	362			SEC16-T14N-R09W
AMC 413918	MPC 126	4861	363			SEC16-T14N-R09W

RECEIVED
 OCT 31 2017
 PHOENIX, ARIZONA

EXHIBIT A

County: Yavapai

State: AZ

<u>BLM Serial #</u>	<u>Claim Name</u>	<u>Original Recording</u>		<u>Amended Recording</u>		<u>Location</u>
		<u>Recording #</u>	<u>Page #</u>	<u>Recording #</u>	<u>Page #</u>	
AMC 418739	Cowboy Wash-16	4924	196			SEC26-T14N-R09W
AMC 418740	Cowboy Wash-17	4924	197			SEC26-T14N-R09W
AMC 418741	Cowboy Wash-18	4924	198			SEC26-T14N-R09W
AMC 418766	Cowboy Wash-43	4924	223			SEC26-T14N-R09W
AMC 418767	Cowboy Wash-44	4924	224			SEC26-T14N-R09W
AMC 418768	Cowboy Wash-45	4924	225			SEC26-T14N-R09W
AMC 418824	GAP-1	4924	97			SEC09-T14N-R09W
AMC 418825	GAP-2	4924	98			SEC09-T14N-R09W
AMC 418826	GAP-3	4924	99			SEC09-T14N-R09W
AMC 418827	GAP-4	4924	100			SEC09-T14N-R09W
AMC 418933	Miller Mountain-26	4924	306			SEC27-T14N-R09W
AMC 418934	Miller Mountain-27	4924	307			SEC27-T14N-R09W
AMC 418935	Miller Mountain-28	4924	308			SEC27-T14N-R09W
AMC 418936	Miller Mountain-29	4924	309			SEC27-T14N-R09W
AMC 418937	Miller Mountain-30	4924	310			SEC27-T14N-R09W
AMC 418938	Miller Mountain-31	4924	311			SEC27-T14N-R09W
AMC 418939	Miller Mountain-32	4924	312			SEC27-T14N-R09W
AMC 418940	Miller Mountain-33	4924	313			SEC27-T14N-R09W
AMC 418941	Miller Mountain-34	4924	314			SEC27-T14N-R09W
AMC 418942	Miller Mountain-35	4924	315			SEC27-T14N-R09W
AMC 418963	Miller Mountain-56	4924	336			SEC27-T14N-R09W
AMC 418964	Miller Mountain-57	4924	337			SEC27-T14N-R09W
AMC 418965	Miller Mountain-58	4924	338			SEC27-T14N-R09W
AMC 418966	Miller Mountain-59	4924	339			SEC27-T14N-R09W
AMC 418967	Miller Mountain-60	4924	340			SEC27-T14N-R09W
AMC 422704	RPC-001	4951	109			SEC30-T14.5N-R08W
AMC 422705	RPC-002	4951	110			SEC30-T14.5N-R08W
AMC 422711	RPC-008	4951	116			SEC30-T14.5N-R08W
AMC 422712	RPC-009	4951	117			SEC30-T14.5N-R08W
AMC 422713	RPC-010	4951	118			SEC30-T14.5N-R08W
AMC 422714	RPC-011	4951	119			SEC30-T14.5N-R08W
AMC 422720	RPC-017	4951	125			SEC30-T14.5N-R08W
AMC 422721	RPC-018	4951	126			SEC30-T14.5N-R08W
AMC 422722	RPC-019	4951	127			SEC30-T14.5N-R08W
AMC 422723	RPC-020	4951	128			SEC30-T14.5N-R08W
AMC 422729	RPC-026	4951	134			SEC30-T14.5N-R08W
AMC 422730	RPC-027	4951	135			SEC30-T14.5N-R08W
AMC 422731	RPC-028	4951	136			SEC30-T14.5N-R08W

RECEIVED
 PHOENIX, ARIZONA
 10/30/2017

EXHIBIT A

County: Yavapai

State: AZ

<u>BLM Serial #</u>	<u>Claim Name</u>	<u>Original Recording</u>		<u>Amended Recording</u>		<u>Location</u>
		<u>Recording #</u>	<u>Page #</u>	<u>Recording #</u>	<u>Page #</u>	
AMC 422732	RPC-029	4951	137			SEC30-T14.5N-R08W
AMC 422733	RPC-030	4951	138			SEC30-T14.5N-R08W
AMC 422737	RPC-034	4951	142			SEC30-T14.5N-R08W
AMC 422738	RPC-035	4951	143			SEC30-T14.5N-R08W
AMC 422739	RPC-036	4951	144			SEC30-T14.5N-R08W
AMC 422740	PB-037	4951	145			SEC23-T15N-R09W
AMC 422741	PB-038	4951	146			SEC23-T15N-R09W
AMC 422742	PB-039	4951	147			SEC23-T15N-R09W
AMC 422743	PB-040	4951	148			SEC23-T15N-R09W
AMC 422744	PB-041	4951	149			SEC23-T15N-R09W
AMC 422745	PB-042	4951	150			SEC23-T15N-R09W
AMC 422746	PB-043	4951	151			SEC23-T15N-R09W
AMC 422747	PB-044	4951	152			SEC23-T15N-R09W
AMC 422748	PB-045	4951	153			SEC23-T15N-R09W
AMC 422749	PB-046	4951	154			SEC23-T15N-R09W
AMC 422750	PB-047	4951	155			SEC23-T15N-R09W
AMC 422751	PB-048	4951	156			SEC23-T15N-R09W
AMC 422752	PB-049	4951	157			SEC23-T15N-R09W
AMC 422753	PB-001	4951	158			SEC24-T15N-R09W
AMC 422754	PB-002	4951	159			SEC24-T15N-R09W
AMC 422755	PB-003	4951	160			SEC24-T15N-R09W
AMC 422756	PB-004	4951	161			SEC24-T15N-R09W
AMC 422757	PB-005	4951	162			SEC24-T15N-R09W
AMC 422758	PB-006	4951	163			SEC24-T15N-R09W
AMC 422759	PB-007	4951	164			SEC24-T15N-R09W
AMC 422760	PB-008	4951	165			SEC24-T15N-R09W
AMC 422761	PB-009	4951	166			SEC24-T15N-R09W
AMC 422762	PB-010	4951	167			SEC24-T15N-R09W
AMC 422763	PB-011	4951	168			SEC24-T15N-R09W
AMC 422764	PB-012	4951	169			SEC24-T15N-R09W
AMC 422765	PB-013	4951	170			SEC24-T15N-R09W
AMC 422766	PB-014	4951	171			SEC24-T15N-R09W
AMC 422767	PB-015	4951	172			SEC24-T15N-R09W
AMC 422768	PB-016	4951	173			SEC24-T15N-R09W
AMC 422769	PB-017	4951	174			SEC24-T15N-R09W
AMC 422770	PB-018	4951	175			SEC24-T15N-R09W
AMC 422771	PB-019	4951	176			SEC24-T15N-R09W
AMC 422772	PB-020	4951	177			SEC24-T15N-R09W

Date: 10/30/2017

RECEIVED
 NOV 1 2017
 ARIZONA
 STATE OFFICE
 PHOENIX, ARIZONA

EXHIBIT A

County: Yavapai

State: AZ

<u>BLM Serial #</u>	<u>Claim Name</u>	<u>Original Recording</u>		<u>Amended Recording</u>		<u>Location</u>
		<u>Recording #</u>	<u>Page #</u>	<u>Recording #</u>	<u>Page #</u>	
AMC 422773	PB-021	4951	178			SEC24-T15N-R09W
AMC 422774	PB-022	4951	179			SEC24-T15N-R09W
AMC 422775	PB-023	4951	180			SEC24-T15N-R09W
AMC 422776	PB-024	4951	181			SEC24-T15N-R09W
AMC 422777	PB-025	4951	182			SEC24-T15N-R09W
AMC 422778	PB-026	4951	183			SEC24-T15N-R09W
AMC 422779	PB-027	4951	184			SEC24-T15N-R09W
AMC 422780	PB-028	4951	185			SEC24-T15N-R09W
AMC 422781	PB-029	4951	186			SEC24-T15N-R09W
AMC 422782	PB-030	4951	187			SEC24-T15N-R09W
AMC 422783	PB-031	4951	188			SEC24-T15N-R09W
AMC 422784	PB-032	4951	189			SEC24-T15N-R09W
AMC 422785	PB-033	4951	190			SEC24-T15N-R09W
AMC 422786	PB-034	4951	191			SEC24-T15N-R09W
AMC 422787	PB-035	4951	192			SEC24-T15N-R09W
AMC 422788	PB-036	4951	193			SEC24-T15N-R09W
AMC 423218	BULL-001	4960	17			SEC08-T14N-R09W
AMC 423219	BULL-002	4960	18			SEC08-T14N-R09W
AMC 423220	BULL-003	4960	19			SEC08-T14N-R09W
AMC 423221	BULL-004	4960	20			SEC08-T14N-R09W
AMC 423222	BULL-005	4960	21			SEC08-T14N-R09W
AMC 423223	BULL-006	4960	22			SEC08-T14N-R09W
AMC 423224	BULL-007	4960	23			SEC08-T14N-R09W
AMC 423225	BULL-008	4960	24			SEC08-T14N-R09W
AMC 423226	BULL-009	4960	25			SEC08-T14N-R09W
AMC 423227	BULL-010	4960	26			SEC08-T14N-R09W
AMC 423228	BULL-011	4960	27			SEC08-T14N-R09W
AMC 423229	BULL-012	4960	28			SEC08-T14N-R09W
AMC 423230	BULL-013	4960	29			SEC08-T14N-R09W
AMC 423231	BULL-014	4960	30			SEC08-T14N-R09W
AMC 423232	BULL-015	4960	31			SEC08-T14N-R09W
AMC 423233	BULL-016	4960	32			SEC08-T14N-R09W
AMC 423234	BULL-017	4960	33			SEC08-T14N-R09W
AMC 423235	BULL-018	4960	34			SEC08-T14N-R09W
AMC 423236	BULL-019	4960	35			SEC08-T14N-R09W
AMC 423237	BULL-020	4960	36			SEC08-T14N-R09W
AMC 423238	BULL-021	4960	37			SEC08-T14N-R09W
AMC 423239	BULL-022	4960	38			SEC08-T14N-R09W

RECEIVED
 0111 AUG 14 2017
 STATE OF ARIZONA
 DEPARTMENT OF REVENUE

EXHIBIT A

County: Yavapai

State: AZ

<u>BLM Serial #</u>	<u>Claim Name</u>	<u>Original Recording</u>		<u>Amended Recording</u>		<u>Location</u>
		<u>Recording #</u>	<u>Page #</u>	<u>Recording #</u>	<u>Page #</u>	
AMC 423240	BULL-023	4960	39			SEC08-T14N-R09W
AMC 423241	BULL-024	4960	40			SEC08-T14N-R09W
AMC 423242	BULL-025	4960	41			SEC08-T14N-R09W
AMC 423243	BULL-026	4960	42			SEC08-T14N-R09W
AMC 423244	BULL-027	4960	43			SEC08-T14N-R09W
AMC 423245	BULL-028	4960	44			SEC17-T14N-R09W
AMC 423246	BULL-029	4960	45			SEC17-T14N-R09W
AMC 423247	BULL-030	4960	46			SEC17-T14N-R09W
AMC 423248	BULL-031	4960	47			SEC17-T14N-R09W
AMC 423249	BULL-032	4960	48			SEC17-T14N-R09W
AMC 423250	BULL-033	4960	49			SEC17-T14N-R09W
AMC 423251	BULL-034	4960	50			SEC17-T14N-R09W
AMC 423252	BULL-035	4960	51			SEC17-T14N-R09W
AMC 423253	BULL-036	4960	52			SEC17-T14N-R09W
AMC 423254	BULL-037	4960	53			SEC17-T14N-R09W
AMC 423255	BULL-038	4960	54			SEC17-T14N-R09W
AMC 423256	BULL-039	4960	55			SEC17-T14N-R09W
AMC 423257	BULL-040	4960	56			SEC17-T14N-R09W
AMC 423258	BULL-041	4960	57			SEC17-T14N-R09W
AMC 423259	BULL-042	4960	58			SEC17-T14N-R09W
AMC 423260	BULL-043	4960	59			SEC17-T14N-R09W
AMC 423261	BULL-044	4960	60			SEC17-T14N-R09W
AMC 423262	BULL-045	4960	61			SEC17-T14N-R09W
AMC 423263	BULL-046	4960	62			SEC17-T14N-R09W
AMC 423264	BULL-047	4960	63			SEC17-T14N-R09W
AMC 423265	BULL-048	4960	64			SEC17-T14N-R09W
AMC 423266	BULL-049	4960	65			SEC17-T14N-R09W
AMC 423267	BULL-050	4960	66			SEC17-T14N-R09W
AMC 423268	BULL-051	4960	67			SEC17-T14N-R09W
AMC 423269	BULL-052	4960	68			SEC17-T14N-R09W
AMC 423270	BULL-053	4960	69			SEC17-T14N-R09W
AMC 423271	BULL-054	4960	70			SEC17-T14N-R09W
AMC 423272	BULL-055	4960	71			SEC17-T14N-R09W
AMC 423273	BULL-056	4960	72			SEC17-T14N-R09W
AMC 423274	BULL-057	4960	73			SEC17-T14N-R09W
AMC 423275	BULL-058	4960	74			SEC17-T14N-R09W
AMC 423276	BULL-059	4960	75			SEC17-T14N-R09W
AMC 423277	BULL-060	4960	76			SEC17-T14N-R09W

RECEIVED
 STATE ENGINEER
 ARIZONA
 2018 AUG 29 9:58 AM

EXHIBIT A

County: Yavapai

State: AZ

BLM Serial #	Claim Name	Original Recording		Amended Recording		Location
		Recording #	Page #	Recording #	Page #	
AMC 423278	BULL-061	4960	77			SEC17-T14N-R09W
AMC 423279	BULL-062	4960	78			SEC17-T14N-R09W
AMC 423280	BULL-063	4960	79			SEC17-T14N-R09W
AMC 423281	BULL-064	4960	80			SEC17-T14N-R09W
AMC 423282	BULL-065	4960	81			SEC17-T14N-R09W
AMC 423283	BULL-066	4960	82			SEC17-T14N-R09W
AMC 423284	BULL-067	4960	83			SEC17-T14N-R09W
AMC 423285	BULL-068	4960	84			SEC17-T14N-R09W
AMC 423286	BULL-069	4960	85			SEC17-T14N-R09W
AMC 423287	BULL-070	4960	86			SEC17-T14N-R09W
AMC 423288	BULL-071	4960	87			SEC17-T14N-R09W
AMC 423289	BULL-072	4960	88			SEC17-T14N-R09W
AMC 423290	BULL-073	4960	89			SEC17-T14N-R09W
AMC 423291	BULL-074	4960	90			SEC17-T14N-R09W
AMC 423292	BULL-075	4960	91			SEC17-T14N-R09W
AMC 423293	BULL-076	4960	92			SEC17-T14N-R09W
AMC 423294	BULL-077	4960	93			SEC17-T14N-R09W
AMC 423295	BULL-078	4960	94			SEC17-T14N-R09W
AMC 423296	BULL-079	4960	95			SEC17-T14N-R09W
AMC 423297	BULL-080	4960	96			SEC17-T14N-R09W
AMC 423298	BULL-081	4960	97			SEC17-T14N-R09W
AMC 423299	BULL-082	4960	98			SEC17-T14N-R09W
AMC 423300	BULL-083	4960	99			SEC17-T14N-R09W
AMC 423301	BULL-084	4960	100			SEC17-T14N-R09W
AMC 423302	BULL-085	4960	101			SEC17-T14N-R09W
AMC 423303	BULL-086	4960	102			SEC17-T14N-R09W
AMC 423304	BULL-087	4960	103			SEC17-T14N-R09W
AMC 423305	BULL-088	4960	104			SEC17-T14N-R09W
AMC 423306	BULL-089	4960	105			SEC17-T14N-R09W
AMC 423307	BULL-090	4960	106			SEC17-T14N-R09W
AMC 423308	BULL-091	4960	107			SEC17-T14N-R09W
AMC 423309	BULL-092	4960	108			SEC17-T14N-R09W
AMC 423310	BULL-093	4960	109			SEC17-T14N-R09W
AMC 423311	BULL-094	4960	110			SEC17-T14N-R09W
AMC 423312	BULL-095	4960	111			SEC17-T14N-R09W
AMC 423313	STEP-001	4960	112			SEC07-T14N-R09W
AMC 423314	STEP-002	4960	113			SEC07-T14N-R09W
AMC 423315	STEP-003	4960	114			SEC07-T14N-R09W

PAID
RECEIPT
1230242

RECEIVED
 CLIMATE STATE OFFICE
 PHOENIX, ARIZONA
 AUG 9 9 58 AM '17

EXHIBIT A

County: Yavapai

State: AZ

<u>BLM Serial #</u>	<u>Claim Name</u>	<u>Original Recording</u>		<u>Amended Recording</u>		<u>Location</u>
		<u>Recording #</u>	<u>Page #</u>	<u>Recording #</u>	<u>Page #</u>	
AMC 423316	STEP-004	4960	115			SEC07-T14N-R09W
AMC 423317	STEP-005	4960	116			SEC07-T14N-R09W
AMC 423318	STEP-006	4960	117			SEC07-T14N-R09W
AMC 423319	STEP-007	4960	118			SEC07-T14N-R09W
AMC 423320	STEP-008	4960	119			SEC07-T14N-R09W
AMC 423321	STEP-009	4960	120			SEC07-T14N-R09W
AMC 423322	STEP-010	4960	121			SEC07-T14N-R09W
AMC 423323	STEP-011	4960	122			SEC08-T14N-R09W
AMC 423324	STEP-012	4960	123			SEC08-T14N-R09W
AMC 423325	STEP-013	4960	124			SEC08-T14N-R09W
AMC 423326	STEP-014	4960	125			SEC08-T14N-R09W
AMC 423327	STEP-015	4960	126			SEC08-T14N-R09W
AMC 423328	STEP-016	4960	127			SEC08-T14N-R09W
AMC 423329	STEP-017	4960	128			SEC08-T14N-R09W
AMC 423330	STEP-018	4960	129			SEC08-T14N-R09W
AMC 423331	STEP-019	4960	130			SEC08-T14N-R09W
AMC 423332	STEP-020	4960	131			SEC08-T14N-R09W
AMC 423333	STEP-021	4960	132			SEC08-T14N-R09W
AMC 423334	STEP-022	4960	133			SEC08-T14N-R09W
AMC 423335	STEP-023	4960	134			SEC08-T14N-R09W
AMC 423336	STEP-024	4960	135			SEC08-T14N-R09W
AMC 423337	STEP-025	4960	136			SEC08-T14N-R09W
AMC 423338	STEP-026	4960	137			SEC08-T14N-R09W
AMC 423339	STEP-027	4960	138			SEC08-T14N-R09W
AMC 423340	STEP-028	4960	139			SEC08-T14N-R09W
AMC 423341	STEP-029	4960	140			SEC08-T14N-R09W
AMC 423342	STEP-030	4960	141			SEC08-T14N-R09W
AMC 423343	STEP-031	4960	142			SEC08-T14N-R09W
AMC 423344	STEP-032	4960	143			SEC08-T14N-R09W
AMC 423345	STEP-033	4960	144			SEC08-T14N-R09W
AMC 423346	STEP-034	4960	145			SEC08-T14N-R09W
AMC 423347	STEP-035	4960	146			SEC08-T14N-R09W
AMC 423348	STEP-036	4960	147			SEC08-T14N-R09W
AMC 423349	STEP-037	4960	148			SEC08-T14N-R09W
AMC 423350	STEP-038	4960	149			SEC08-T14N-R09W
AMC 423351	STEP-039	4960	150			SEC17-T14N-R09W
AMC 423352	STEP-040	4960	151			SEC17-T14N-R09W
AMC 423353	STEP-041	4960	152			SEC17-T14N-R09W

Date: 10/30/2017

RECEIVED
 P M AZ STATE OFFICE
 2018 AUG -9 A 9:58
 PHOENIX ARIZONA

EXHIBIT A

County: Yavapai

State: AZ

BLM Serial #	Claim Name	Original Recording		Amended Recording		Location
		Recording #	Page #	Recording #	Page #	
AMC 423354	STEP-042	4960	153			SEC17-T14N-R09W
AMC 423355	STEP-043	4960	154			SEC17-T14N-R09W
AMC 423356	STEP-044	4960	155			SEC17-T14N-R09W
AMC 423357	STEP-045	4960	156			SEC08-T14N-R09W
AMC 423358	STEP-046	4960	157			SEC08-T14N-R09W
AMC 423359	STEP-047	4960	158			SEC08-T14N-R09W
AMC 423360	STEP-048	4960	159			SEC08-T14N-R09W
AMC 423361	STEP-049	4960	160			SEC08-T14N-R09W
AMC 423362	STEP-050	4960	161			SEC08-T14N-R09W
AMC 423363	STEP-051	4960	162			SEC17-T14N-R09W
AMC 423364	STEP-052	4960	163			SEC17-T14N-R09W
AMC 423365	STEP-053	4960	164			SEC17-T14N-R09W
AMC 423366	STEP-054	4960	165			SEC17-T14N-R09W
AMC 423367	STEP-055	4960	166			SEC17-T14N-R09W
AMC 423368	STEP-056	4960	167			SEC17-T14N-R09W
AMC 423369	STEP-057	4960	168			SEC17-T14N-R09W
AMC 423370	STEP-058	4960	169			SEC17-T14N-R09W
AMC 423371	STEP-059	4960	170			SEC17-T14N-R09W
AMC 423372	STEP-060	4960	171			SEC17-T14N-R09W
AMC 423373	STEP-061	4960	172			SEC17-T14N-R09W
AMC 425400	OSL-001	4995	454			SEC35-T15N-R09W
AMC 425401	OSL-002	4995	455			SEC35-T15N-R09W
AMC 425402	OSL-003	4995	456			SEC35-T15N-R09W
AMC 425403	OSL-004	4995	457			SEC35-T15N-R09W
AMC 425404	OSL-005	4995	458			SEC35-T15N-R09W
AMC 425405	OSL-006	4995	459			SEC35-T15N-R09W
AMC 425406	OSL-007	4995	460			SEC35-T15N-R09W
AMC 425407	OSL-008	4995	461			SEC35-T15N-R09W
AMC 425408	OSL-009	4995	462			SEC35-T15N-R09W
AMC 425409	OSL-010	4995	463			SEC02-T14N-R09W
AMC 425410	OSL-011	4995	464			SEC02-T14N-R09W
AMC 425411	OSL-012	4995	465			SEC02-T14N-R09W
AMC 425412	OSL-013	4995	466			SEC02-T14N-R09W
AMC 425413	OSL-014	4995	467			SEC02-T14N-R02W
AMC 425414	OSL-015	4995	468			SEC02-T14N-R09W
AMC 425415	OSL-016	4995	469			SEC02-T14N-R02W
AMC 425416	OSL-017	4995	470			SEC02-T14N-R09W
AMC 425417	OSL-018	4995	471			SEC02-T14N-R09W

Date: 10/30/2017

Page 27

RECEIVED
 CHENIX ARIZONA
 10/30/17 9:58 AM

EXHIBIT A

County: Yavapai

State: AZ

BLM Serial #	Claim Name	Original Recording		Amended Recording		Location
		Recording #	Page #	Recording #	Page #	
AMC 425418	OSL-019	4995	472			SEC02-T14N-R09W
AMC 425419	OSL-020	4995	473			SEC02-T14N-R09W
AMC 425420	OSL-021	4995	474			SEC02-T14N-R09W
AMC 425421	OSL-022	4995	475			SEC35-T15N-R09W
AMC 425422	OSL-023	4995	476			SEC35-T15N-R09W
AMC 425423	OSL-024	4995	477			SEC35-T15N-R09W
AMC 425424	OSL-025	4995	478			SEC35-T15N-R09W
AMC 425425	OSL-026	4995	479			SEC35-T15N-R09W
AMC 425426	OSL-027	4995	480			SEC35-T15N-R09W
AMC 425427	OSL-028	4995	481			SEC35-T15N-R09W
AMC 425428	OSL-029	4995	482			SEC35-T15N-R09W
AMC 425429	OSL-030	4995	483			SEC35-T15N-R09W
AMC 425430	OSL-031	4995	484			SEC35-T15N-R09W
AMC 425431	OSL-032	4995	485			SEC35-T15N-R09W
AMC 425432	OSL-033	4995	486			SEC35-T15N-R09W
AMC 425433	OSL-034	4995	487			SEC35-T15N-R09W
AMC 425434	OSL-035	4995	488			SEC35-T15N-R09W
AMC 425435	OSL-036	4995	489			SEC35-T15N-R09W
AMC 425436	OSL-037	4995	490			SEC35-T15N-R09W
AMC 425437	OSL-038	4995	491			SEC35-T15N-R09W
AMC 425438	OSL-039	4995	492			SEC35-T15N-R09W
AMC 425439	OSL-040	4995	493			SEC02-T14N-R09W
AMC 425440	OSL-041	4995	494			SEC02-T14N-R09W
AMC 425441	OSL-042	4995	495			SEC02-T14N-R09W
AMC 425442	OSL-043	4995	496			SEC02-T14N-R09W
AMC 425443	OSL-044	4995	497			SEC02-T14N-R09W
AMC 425444	OSL-045	4995	498			SEC02-T14N-R09W
AMC 425445	OSL-046	4995	499			SEC02-T14N-R09W
AMC 425446	OSL-047	4995	500			SEC02-T14N-R09W
AMC 425447	OSL-048	4995	501			SEC02-T14N-R09W
AMC 425448	OSL-049	4995	502			SEC02-T14N-R09W
AMC 425449	OSL-050	4995	503			SEC02-T14N-R09W
AMC 425450	OSL-051	4995	504			SEC02-T14N-R09W
AMC 425451	OSL-052	4995	505			SEC02-T14N-R09W
AMC 425452	OSL-053	4995	506			SEC02-T14N-R09W
AMC 425453	OSL-054	4995	507			SEC02-T14N-R09W
AMC 425454	OSL-055	4995	508			SEC02-T14N-R09W
AMC 425455	OSL-056	4995	509			SEC35-T15N-R09W

RECEIVED
 ARIZONA STATE OFFICE
 PHOENIX
 10/30/17

EXHIBIT A

County: Yavapai

State: AZ

BLM Serial #	Claim Name	Original Recording		Amended Recording		Location
		Recording #	Page #	Recording #	Page #	
AMC 425456	OSL-057	4995	510			SEC35-T15N-R09W
AMC 425457	OSL-058	4995	511			SEC35-T15N-R09W
AMC 425458	OSL-059	4995	512			SEC35-T15N-R09W
AMC 425459	OSL-060	4995	513			SEC35-T15N-R09W
AMC 425460	OSL-061	4995	514			SEC35-T15N-R09W
AMC 425461	OSL-062	4995	515			SEC35-T15N-R09W
AMC 425462	OSL-063	4995	516			SEC35-T15N-R09W
AMC 425463	OSL-064	4995	517			SEC35-T15N-R09W
AMC 425464	OSL-065	4995	518			SEC01-T14N-R09W
AMC 425465	OSL-066	4995	519			SEC01-T14N-R09W
AMC 425466	OSL-067	4995	520			SEC01-T14N-R09W
AMC 425467	OSL-068	4995	521			SEC01-T14N-R09W
AMC 425468	OSL-069	4995	522			SEC01-T14N-R09W
AMC 425469	OSL-070	4995	523			SEC01-T14N-R09W
AMC 425470	OSL-071	4995	524			SEC01-T14N-R09W
AMC 425471	OSL-072	4995	525			SEC01-T14N-R09W
AMC 425472	OSL-073	4995	526			SEC01-T14N-R09W
AMC 425473	OSL-074	4995	527			SEC01-T14N-R09W
AMC 425474	OSM-001	4995	528			SEC10-T14N-R09W
AMC 425475	OSM-002	4995	529			SEC10-T14N-R09W
AMC 425476	OSM-003	4995	530			SEC10-T14N-R09W
AMC 425477	OSM-004	4995	531			SEC10-T14N-R09W
AMC 425478	OSM-005	4995	532			SEC10-T14N-R09W
AMC 429339	SKUNK-1	2014-0043084				SEC30-T14N-R09W
AMC 429340	SKUNK-2	2014-0043085				SEC30-T14N-R09W
AMC 429341	SKUNK-3	2014-0043086				SEC30-T14N-R09W
AMC 429342	SKUNK-4	2014-0043087				SEC30-T14N-R09W
AMC 429343	SKUNK-5	2014-0043088				SEC30-T14N-R09W
AMC 429344	SKUNK-6	2014-0043089				SEC30-T14N-R09W
AMC 435511	NM-001	2015-0055592				SEC30-T14.5N-R08W
AMC 435512	NM-002	2015-0055593				SEC30-T14.5N-R08W
AMC 435513	NM-003	2015-0055594				SEC30-T14.5N-R08W
AMC 435514	NM-004	2015-0055595				SEC30-T14.5N-R08W
AMC 435515	NM-005	2015-0055596				SEC30-T14.5N-R08W
AMC 435516	NM-006	2015-0055597				SEC30-T14.5N-R08W
AMC 435517	NM-007	2015-0055598				SEC30-T14.5N-R08W
AMC 435518	NM-008	2015-0055599				SEC30-T14.5N-R08W
AMC 435519	NM-009	2015-0055600				SEC30-T14.5N-R08W

RECEIVED
 COUNTY OF YAVAPAI
 CLERK OF SUPERIOR COURT
 2017 AUG 29 9:58 AM

EXHIBIT A

County: Yavapai

State: AZ

<u>BLM Serial #</u>	<u>Claim Name</u>	<u>Original Recording</u>		<u>Amended Recording</u>		<u>Location</u>
		<u>Recording #</u>	<u>Page #</u>	<u>Recording #</u>	<u>Page #</u>	
AMC 435520 7	NM-010	2015-0055601				SEC30-T14.5N-R08W
AMC 435521	NM-011	2015-0055602				SEC30-T14.5N-R08W
AMC 435522	NM-012	2015-0055603				SEC30-T14.5N-R08W
AMC 435523	NM-013	2015-0055604				SEC30-T14.5N-R08W
AMC 435524	NM-014	2015-0055605				SEC30-T14.5N-R08W
AMC 435525	NM-015	2015-0055606				SEC30-T14.5N-R08W
AMC 435526	NM-016	2015-0055607				SEC30-T14.5N-R08W
AMC 435527	NM-017	2015-0055608				SEC30-T14.5N-R08W
AMC 435528]	NM-018	2015-0055609				SEC30-T14.5N-R08W
AMC 445836 7	AEJ-1	2017-0049391				SEC26-T14N-R09W
AMC 445837	AEJ-2	2017-0049392				SEC26-T14N-R09W
AMC 445838]	AEJ-3	2017-0049393				SEC26-T14N-R09W
No. Of Claims	1108					

RECEIVED
PHOENIX, ARIZONA
2018 AUG - 9 A 9:58
PHOENIX, ARIZONA STATE OFFICE

United States Department of the Interior
Bureau of Land Management
 DIV OF LANDS, MINRLS & ENERGY
 ONE N CENTRAL AVE
 PHOENIX, AZ 85004 -4427
 Phone: 602-417-9200

Receipt

No: 4230944

Transaction #: 4346226	
Date of Transaction: 08/09/2018	
CUSTOMER:	
FREEPORT MCMORAN INC 333 N CENTRAL AVE PHOENIX, AZ 85004-2121 US	

LINE #	QTY	DESCRIPTION	REMARKS	UNIT PRICE	TOTAL
1	1.00	LOCATABLE MINERALS / MINING CLAIMS-NOT NEW-UNADJUD, ONE AUTH NO. ONLY / MINING CLAIM MONEY RECEIVED CASES: AMC31840/\$171740.00	2019 MAINT/1108	- n/a -	171740.00
TOTAL:					\$171,740.00

PAYMENT INFORMATION					
1	AMOUNT:	171740.00	POSTMARKED:	N/A	
	TYPE:	CHECK	RECEIVED:	08/09/2018	
	CHECK NO:	0000902242			
	NAME:	FREEPORT MCMORAN INC 333 N CENTRAL AVE PHOENIX AZ 85004-2121 US			

REMARKS

This receipt was generated by the automated BLM Collections and Billing System and is a paper representation of a portion of the official electronic record contained therein.

NOTICE!!

These documents have been scanned!

Do not place un-scanned documents beneath this notice!

Do not remove this notice from this file!

GPO Jacket No. 560-102
Print Order 61540
Rise Business Services, LLC
Job=AZ15 4/29/2019



Box Number= AZ15006



Claim Begin-End: AMC445836-AMC445838

5 Miscellaneous



AZ15006-37

AMC450400-AMC453366

**NO
DOCUMENTS
FOUND**

NO DOCUMENTS FOUND
NO DOCUMENTS FOUND

NOTICE!!

These documents have been scanned!

Do not place un-scanned documents beneath this notice!

Do not remove this notice from this file!

GPO Jacket No. 560-102
Print Order 61540
Rise Business Services, LLC
Job=AZ15 4/29/2019



Box Number= AZ15006



Claim Begin-End: AMC445836-AMC445838

6 Location Notices-Amendments and Supporting Documents



AZ15006-37

AMC450400-AMC453366

MINING CLAIM STATUS REPORT

Data Entered: 9/27/17 RSM

MTP Checked By: PER
GEO Checked By: _____

LEAD SERIAL NUMBER: AMC 445836 thru AMC 445838

NUMBER OF CLAIMS & TYPE:

3 LODE
____ PLACER
____ ASSOCIATION PLACER
____ MILL SITE
____ TUNNEL SITE

CHARGES:

Processing Fee @ \$20 = \$ 60⁰⁰
Location Fee @ \$37 = \$ 111⁰⁰
Maintenance Fee @ \$155 = \$ 465⁰⁰
Add'l Maint Fee for Assoc Placer = \$ _____
SUBTOTAL \$ 636⁰⁰
Other Fees \$ _____
Other Fees \$ _____
TOTAL \$ _____

TOTAL ACREAGE: _____ Per Claim
(Placer Only)

NUMBER OF LOCATORS: 1

DOCUMENTS RECEIVED VIA: Over-the-Counter Mail **TIMELY FILED:** Yes No

LEGAL DESCRIPTION: T 14N R 9W SEC 26
T _____ R _____ SEC _____
T _____ R _____ SEC _____
T _____ R _____ SEC _____
T _____ R _____ SEC _____

BLM FOREST SERVICE _____ SUBJ TO PL 359: Yes No
WILDERNESS AREA _____

SPLIT ESTATE: N/A SX PX OTHER
SRHA Was proper Notice filed if located on SHRA Land? Yes No

RECONVEYED MINERALS ON BLM LAND REQUIRE OPENING ORDER FROM 1944 TO 1993:

Open to Entry On _____ N/A

COMMENTS/STATUS: VOID PARTIALLY VOID PVT MINERALS WITHDRAWN LANDS

OTHER within Patent #1114279 - US MINERALS

Claimant acknowledges that portions of the following claim(s) site(s) may be void or voidable.

Printed Name of Claimant _____ Signature of Claimant _____

*****FINAL ADJUDICATION*****

DATE 5/14/18 INITIALS PR

Return to:
Freeport-McMoRan Bagdad Inc.
PO Box 245
Bagdad, AZ 86321

**LOCATION NOTICE FOR LODE MINING CLAIM
STATE OF ARIZONA, COUNTY OF YAVAPAI**

NOTICE IS HEREBY GIVEN that the **AEJ-1** Lode mining claim has been located by:

Freeport-McMoRan Bagdad Inc.,
whose current mailing address is:
PO Box 245, Bagdad, AZ 86321.

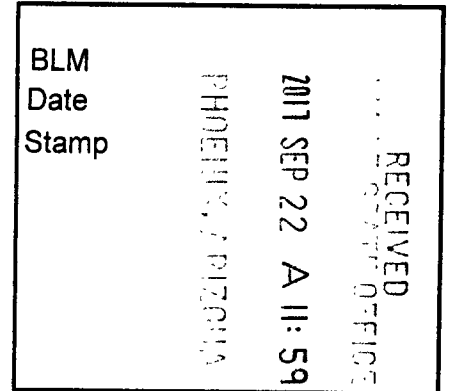

This Lode mining claim consists of approximately **16** acres. The general course of this claim is **North to South** and it is situated in the Eureka Mining District, Yavapai County, Arizona. This claim is **1,320** feet in length and **528** feet in width. This claim runs from the location monument on which this location notice is posted approximately **10** feet in an **Northerly** direction to the **North** end line and **1,310** feet in a **Southerly** direction to the **South** end line. This claim is marked by six monuments, one at each corner and one at the center of each end line of the claim.

The location monument on which the notice is posted is situated within:

Section 26, Township 14 North, Range 9 West, Gila and Salt River Meridian, Yavapai County, Arizona and this claim encompasses portions of the following quarter section(s), section(s), Township(s) and Range(s): **SW ¼, Section 26, T14N-R9W, G&SRM, Yavapai County, Arizona.**

The locality of this claim with reference to some natural object or permanent monument and additional information (if any) concerning its locality is as follows:

The Southwest corner of this claim is on the Southwest corner of Section 26, T14N-R9W.

The undersigned claims the ground as described above and set forth on the attached 1" = 1000' outline map. This claim is not intended to encroach on any private property or land that is not open for location.

Located, dated and posted on the ground this 12th day of September, 2017.

Freeport-McMoRan Bagdad Inc. (Owner)

By: 
Jody A. Stone, RLS (Agent)

AMC 445836

'AEJ-1" LODE CLAIM

LOCATION OF THE "AEJ-1", "AEJ-2" & "AEJ-3" LODE CLAIMS

ALL CLAIMS ARE 1320' IN LENGTH & 528' IN WIDTH
 SITUATED IN SECTION 26, T14N-R9W
 EUREKA MINING DISTRICT, YAVAPAI COUNTY, AZ

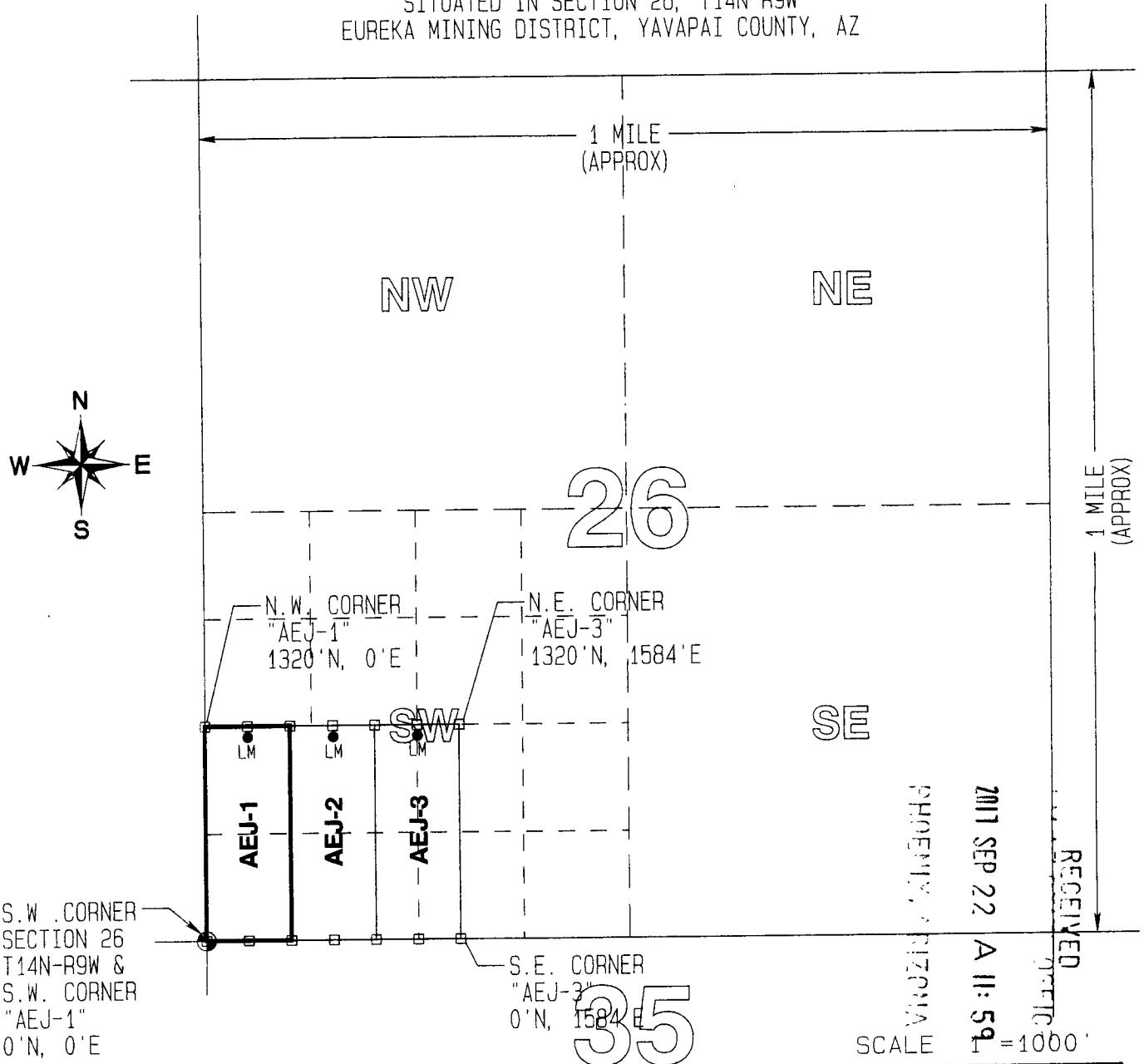

S.W. CORNER
 SECTION 26
 T14N-R9W &
 S.W. CORNER
 "AEJ-1"
 0' N, 0' E

S.E. CORNER
 "AEJ-3"
 0' N, 1584' E

LEGEND

- CLAIM ACREAGE = 16 +/- ACRES
- INDICATES END CENTER OR CORNER OF LODE CLAIM. SET 2"x2"x5' WOODEN POST. (TYPICAL).
- LM ● INDICATES LOCATION MONUMENT. SET 2"x2"x5' WOODEN POST 10' AN FROM END CENTER ON THE CENTER LINE OF THE CLAIM, WITH A PLASTIC BOTTLE CONTAINING THE LOCATION NOTICE. (TYPICAL).

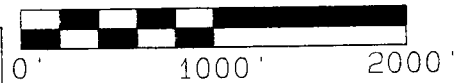
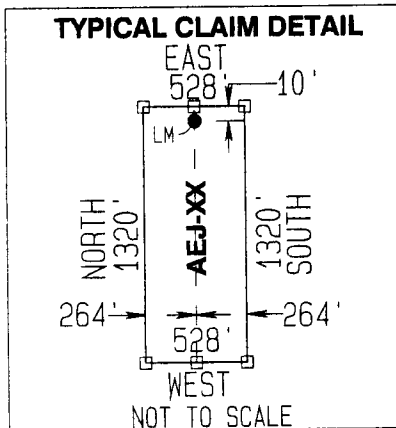

LOCATORS:

FREEPORT-MCMORAN
 BAGDAD, INC.
 PO BOX 245
 BAGDAD AZ 86321

AR 0115823

Return to:
Freeport-McMoRan Bagdad Inc.
PO Box 245
Bagdad, AZ 86321

**LOCATION NOTICE FOR LODE MINING CLAIM
STATE OF ARIZONA, COUNTY OF YAVAPAI**

NOTICE IS HEREBY GIVEN that the **AEJ-2** Lode mining claim has been located by:

Freeport-McMoRan Bagdad Inc.,
whose current mailing address is:
PO Box 245, Bagdad, AZ 86321.

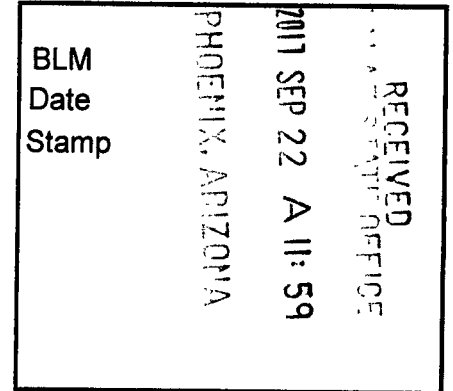

This Lode mining claim consists of approximately **16** acres. The general course of this claim is **North to South** and it is situated in the Eureka Mining District, Yavapai County, Arizona. This claim is **1,320** feet in length and **528** feet in width. This claim runs from the location monument on which this location notice is posted approximately **10** feet in an **Northerly** direction to the **North** end line and **1,310** feet in a **Southerly** direction to the **South** end line. This claim is marked by six monuments, one at each corner and one at the center of each end line of the claim.

The location monument on which the notice is posted is situated within:

Section 26, Township 14 North, Range 9 West, Gila and Salt River Meridian, Yavapai County, Arizona and this claim encompasses portions of the following quarter section(s), section(s), Township(s) and Range(s): **SW ¼, Section 26, T14N-R9W, G&SRM, Yavapai County, Arizona.**

The locality of this claim with reference to some natural object or permanent monument and additional information (if any) concerning its locality is as follows:

The Southwest corner of this claim is 528 feet East of the Southwest corner of Section 26, T14N-R9W.

The undersigned claims the ground as described above and set forth on the attached 1" = 1000' outline map. This claim is not intended to encroach on any private property or land that is not open for location.

Located, dated and posted on the ground this 12th day of September, 2017.

Freeport-McMoRan Bagdad Inc. (Owner)

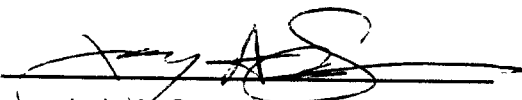
By: 
Jody A. Stone, RLS (Agent)

AMC 11 5837

'AEJ-2" LODE CLAIM

LOCATION OF THE "AEJ-1", "AEJ-2" & "AEJ-3" LODE CLAIMS

ALL CLAIMS ARE 1320' IN LENGTH & 528' IN WIDTH
 SITUATED IN SECTION 26, T14N-R9W
 EUREKA MINING DISTRICT, YAVAPAI COUNTY, AZ

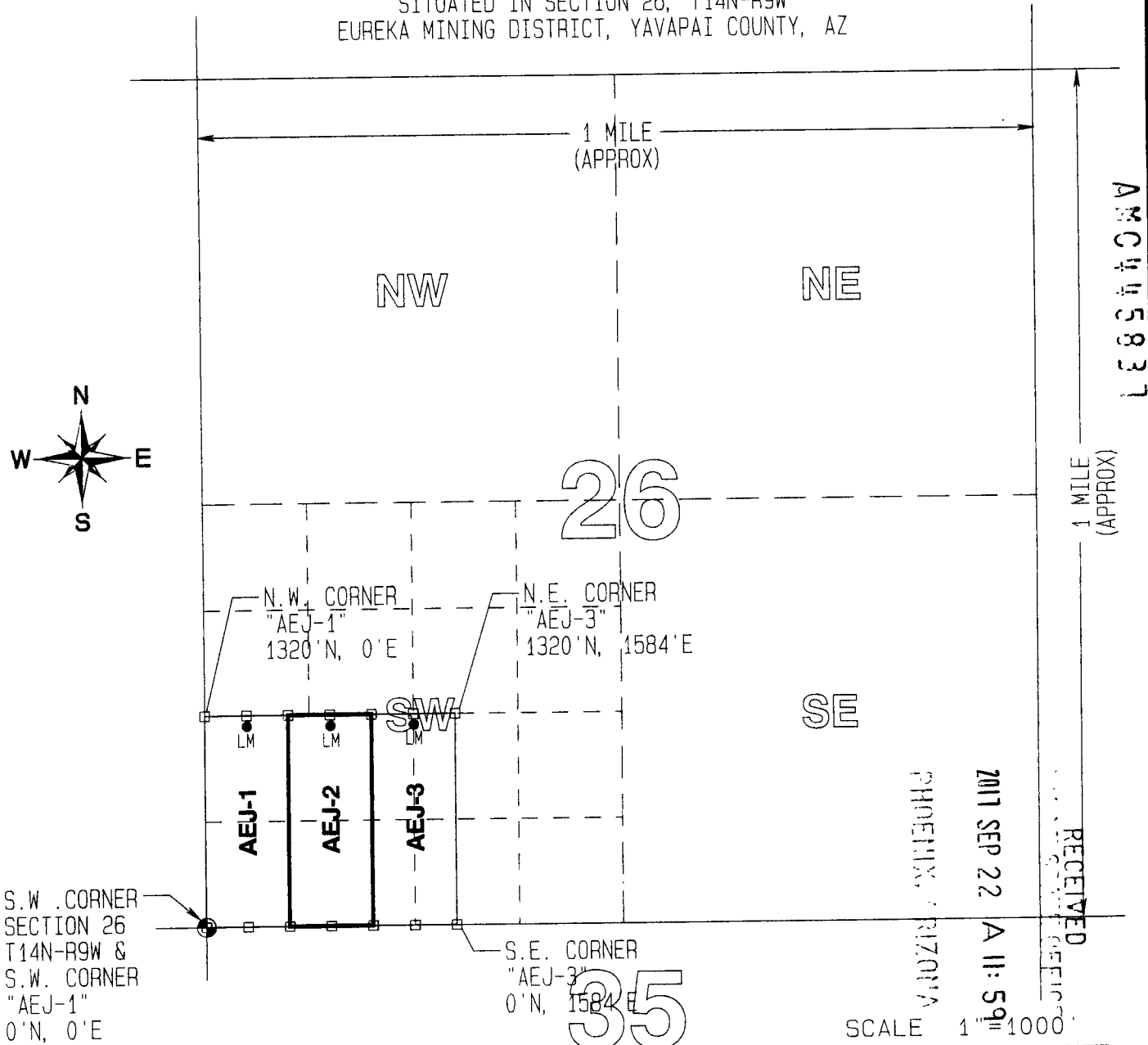

LEGEND

CLAIM ACREAGE = 16 +/- ACRES

□ INDICATES END CENTER OR CORNER OF LODE CLAIM SET 2"x2"x5' WOODEN POST. (TYPICAL).

LM ● INDICATES LOCATION MONUMENT. SET 2"x2"x5' WOODEN POST 10' AN FROM END CENTER ON THE CENTER LINE OF THE CLAIM, WITH A PLASTIC BOTTLE CONTAINING THE LOCATION NOTICE. (TYPICAL).

TYPICAL CLAIM DETAIL

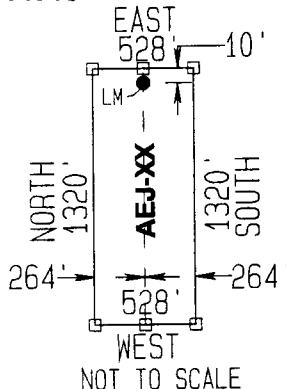

LOCATORS:

FREEMPORT-MCMORAN
 BAGDAD, INC.
 PO BOX 245
 BAGDAD AZ 86321

Return to:
Freeport-McMoRan Bagdad Inc.
PO Box 245
Bagdad, AZ 86321

**LOCATION NOTICE FOR LODE MINING CLAIM
STATE OF ARIZONA, COUNTY OF YAVAPAI**

NOTICE IS HEREBY GIVEN that the **AEJ-3** Lode mining claim has been located by:

Freeport-McMoRan Bagdad Inc.,
whose current mailing address is:
PO Box 245, Bagdad, AZ 86321.

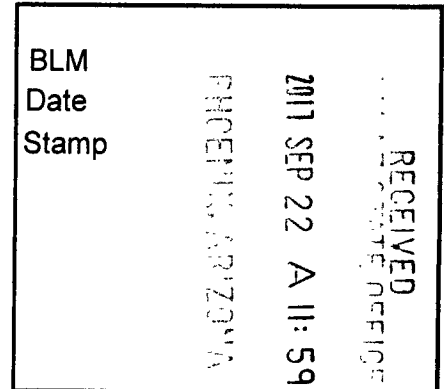

This Lode mining claim consists of approximately **16** acres. The general course of this claim is **North to South** and it is situated in the Eureka Mining District, Yavapai County, Arizona. This claim is **1,320** feet in length and **528** feet in width. This claim runs from the location monument on which this location notice is posted approximately **10** feet in an **Northerly** direction to the **North** end line and **1,310** feet in a **Southerly** direction to the **South** end line. This claim is marked by six monuments, one at each corner and one at the center of each end line of the claim.

The location monument on which the notice is posted is situated within:

Section 26, Township 14 North, Range 9 West, Gila and Salt River Meridian, Yavapai County, Arizona and this claim encompasses portions of the following quarter section(s), section(s), Township(s) and Range(s): **SW ¼, Section 26, T14N-R9W, G&SRM, Yavapai County, Arizona.**

The locality of this claim with reference to some natural object or permanent monument and additional information (if any) concerning its locality is as follows:

The Southwest corner of this claim is 1,056 feet East of the Southwest corner of Section 26, T14N-R9W.

The undersigned claims the ground as described above and set forth on the attached 1" = 1000' outline map. This claim is not intended to encroach on any private property or land that is not open for location.

Located, dated and posted on the ground this 12th day of September, 2017.

Freeport-McMoRan Bagdad Inc. (Owner)

By: 
Jody A. Stone, RLS (Agent)

AMC 1115938

'AEJ-3" LODE CLAIM

LOCATION OF THE "AEJ-1", "AEJ-2" & "AEJ-3" LODE CLAIMS

ALL CLAIMS ARE 1320' IN LENGTH & 528' IN WIDTH
 SITUATED IN SECTION 26, T14N-R9W
 EUREKA MINING DISTRICT, YAVAPAI COUNTY, AZ

AUG 11 2011

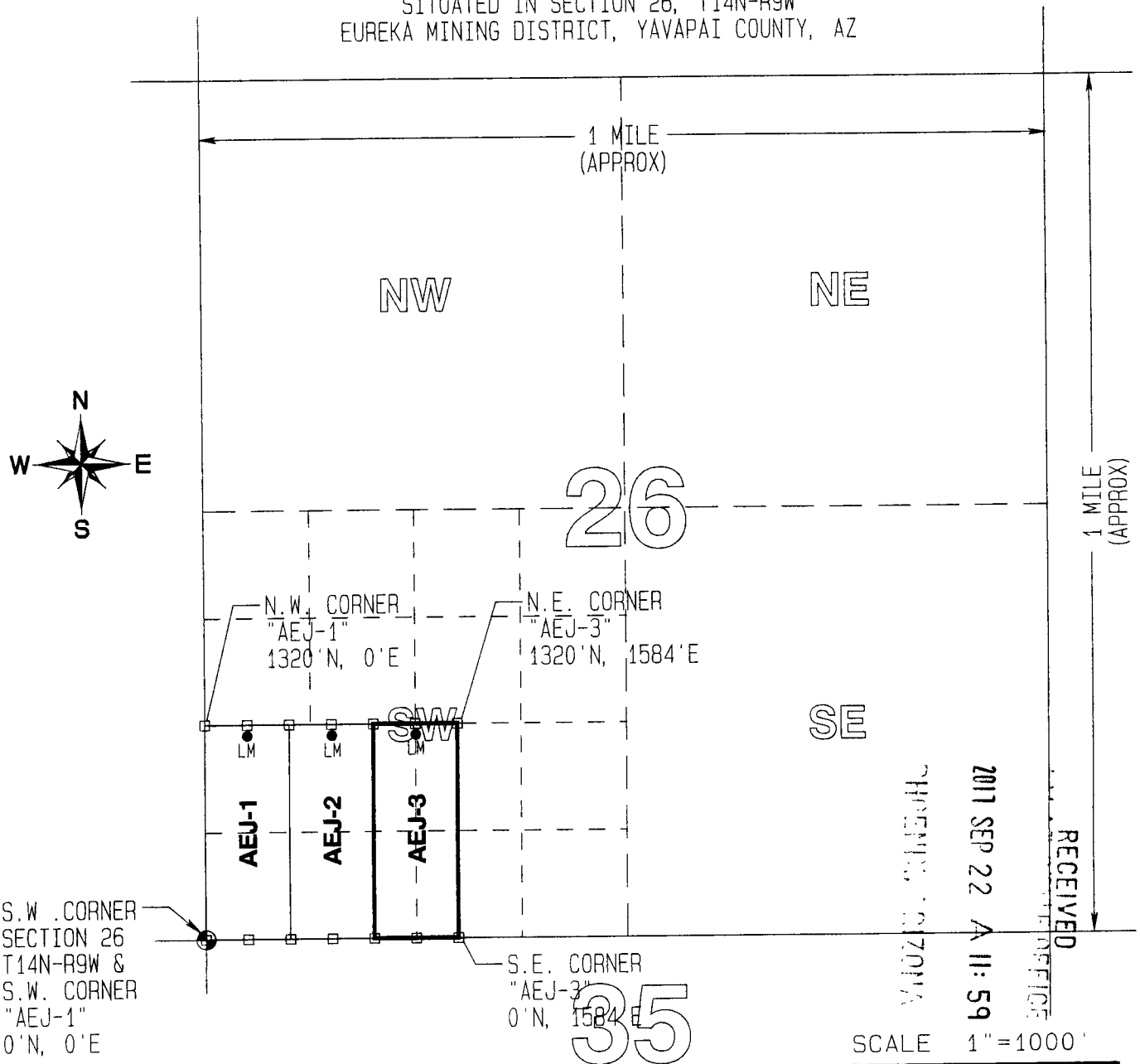

S.W. CORNER SECTION 26 T14N-R9W & S.W. CORNER "AEJ-1" 0'N, 0'E

N.W. CORNER "AEJ-1" 1320'N, 0'E
 N.E. CORNER "AEJ-3" 1320'N, 1584'E

S.E. CORNER "AEJ-3" 0'N, 1584'E

RECEIVED
 2011 SEP 22 A 11:59
 OFFICE

LEGEND

- CLAIM ACREAGE = 16 +/- ACRES
- INDICATES END CENTER OR CORNER OF LODE CLAIM. SET 2"x2"x5' WOODEN POST. (TYPICAL).
- LM ● INDICATES LOCATION MONUMENT. SET 2"x2"x5' WOODEN POST 10' AN FROM END CENTER ON THE CENTER LINE OF THE CLAIM, WITH A PLASTIC BOTTLE CONTAINING THE LOCATION NOTICE. (TYPICAL).

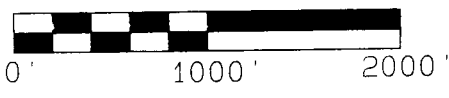
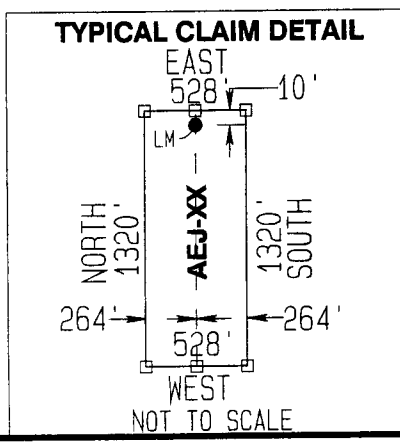

LOCATORS:
 FREEPORT-MCMORAN
 BAGDAD, INC.
 PO BOX 245
 BAGDAD AZ 86321

TOWNSHIP 14 NORTH RANGE 9 WEST OF THE GILA AND SALT RIVER MERIDIAN, ARIZONA

YAVAPAI COUNTY
KINGMAN FIELD OFFICE

STATUS OF PUBLIC DOMAIN
LAND AND MINERAL TITLES

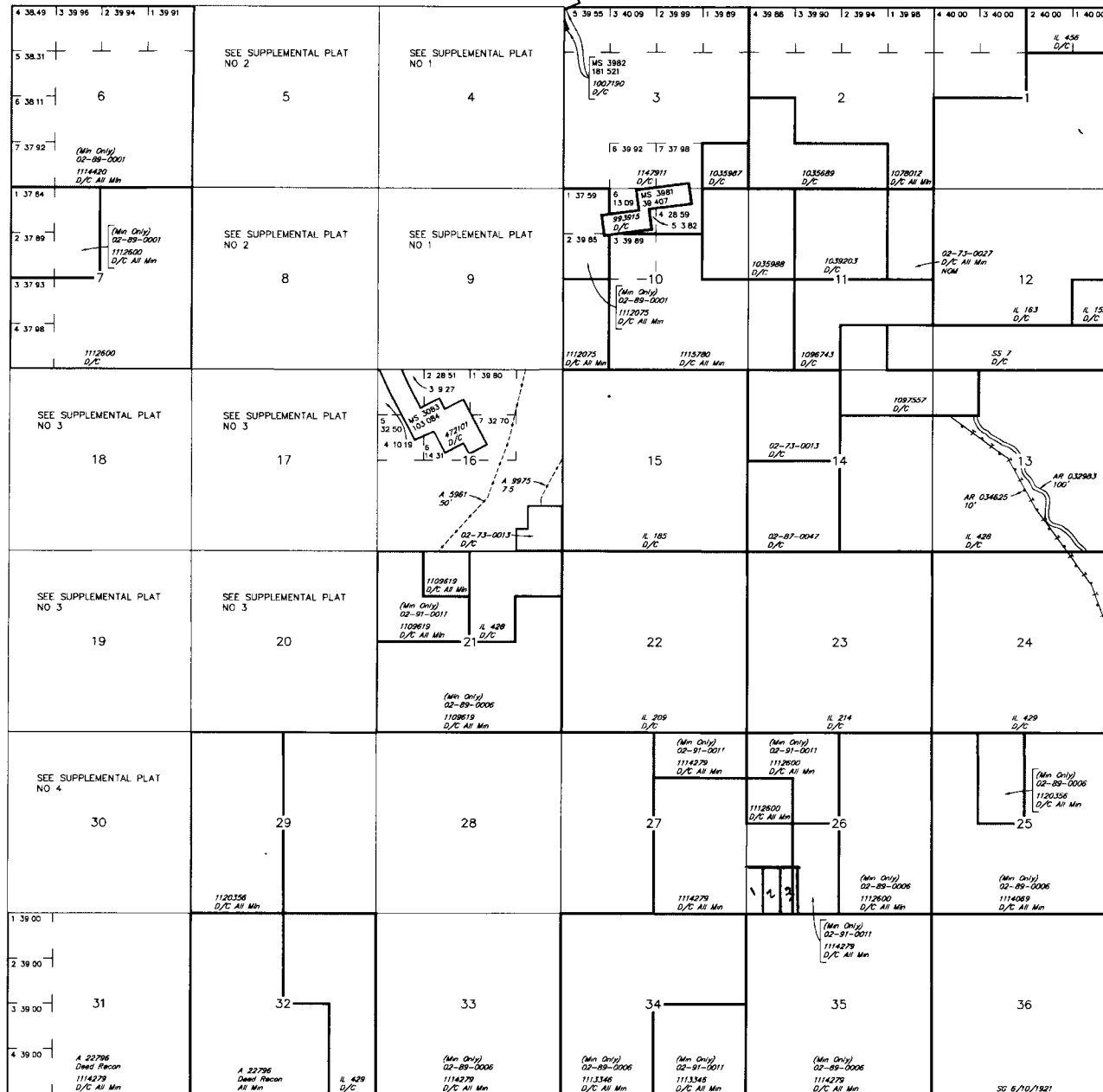

INDEX TO SEGREGATED TRACTS				
TRACT NO	ORIGINAL SURVEY			SUBDIVISION
	T	R	SEC.	

FOR ORDERS AFFECTING DISPOSAL OR USE OF UNIDENTIFIED LANDS WITHDRAWN FOR CLASSIFICATION, MINERALS, WATER AND/OR OTHER PUBLIC PURPOSES, REFER TO INDEX OF MISCELLANEOUS DOCUMENTS

MDS 333 NE
334 NW
335 SW

AZA 31478 R/W 25'

Sec 8 Lot 11
Sec 17 Lot 3, W1/2NE1/4, NE1/4SW1/4
Sec 32 E1/2W1/2

Lat 34 30'03"N
Long 113 08'58"W

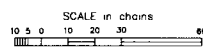

WARNING STATEMENT
This plot is the Bureau's Record of Title, and should be used only as a graphic display of the current survey data. Records herein do not reflect title changes which may have been effected by later monuments of rivers or other bodies of water. Refer to the cadastral surveys for official survey information.

CURRENT TO	NW	GSR Mer	
B-28-2015	ACAD.		T 14 N
			R 9 W

TOWNSHIP 14 NORTH RANGE 09 WEST OF THE GILA & SALT RIVER MERIDIAN, ARIZONA

SECS	SUBDIVISION																Acres	Kind of Entry or Purpose	Serial Number or Order Number	Action Date	Remarks				
	NE 1/4				NW 1/4				SW 1/4				SE 1/4									Lots	Other Description		
	NE	NW	SW	SE	NE	NW	SW	SE	NE	NW	SW	SE	NE	NW	SW	SE									
For orders affecting disposal or use of unidentified lands withdrawn for classification, minerals, water, and/or other public purposes, and Indian treaties, refer to Index to Miscellaneous Documents																									
4																		MS 761 (LOT 37),	19 97	PATENT / ME	14654	1/28/1889	MC 157,		
4																		MS 763 (LOT 38),	19 88	PATENT / ME	14655	1/28/1889	MC 152,		
4																		MS 768 (LOT 42),	9 47	PATENT / ME	14657	1/28/1889	MC 156,		
4																									
5																		MS 764 (LOT 39),	18 94	PATENT / ME	14725	2/21/1889	MC 153, 15N 9W,		
4																		MS 765 (LOT 40),	16 66	PATENT / ME	14726	2/21/1889	MC 154,		
4																									
5																		MS 780 (LOT 44)	20 52	PATENT / ME	14981	5/17/1889	MC 159		
4																		MS 779 (LOT 43),	10 33	PATENT / ME	15831	3/22/1890	MC 158,		
17																									
20																		MS 968 (LOT 52),	20 66	PATENT / ME	21247	5/11/1892	MC 228,		
8																		MS 967 (LOT 51),	20 66	PATENT / ME	22863	5/1/1893	MC 229,		
17																									
20																		MS 1596,	20 66	PATENT / ME	37042	9/19/1903	MC 503,		
20																		MS 1595,	18 37	PATENT / ME	37092	9/28/1903	MC 502,		
18																									
19																		MS 1685A,	25 064	PATENT / ME	38848	6/2/1904	MC 544, 16N 10W,		
19																									
20																		MS 1684A,	25 114	PATENT / ME	38849	6/2/1904	MC 545, 15N 8W,		
																		ALL SECS 2, 16, 32, 36,		STATE GRANT	ACT OF CONGRESS	6/20/1910	TITLE TO STATE TO FIX ON APPROVAL OF SURVEY, SUBJECT TO PRIOR RIGHTS,		
4																									
5																		MS 2818,	779 517	PATENT / ME	292831	9/20/1912	15N 9W,		
8																									
9																									
16																		MS 3083,	103 084	PATENT / ME	472101	5/8/1915			
8																		MS 3035,	102 895	PATENT / ME	483950	7/26/1915			
4																									
5																		MS 3186,	39 421	PATENT / ME	525133	4/19/1916			
8																									
17																		MS 3189,	20 661	PATENT / ME	537038	7/7/1916			
1					X	X	X	X	X	X	X								3, 4		320 00	SRHE	PHX-054388	2/8/1923	REL 10/16/1926,

TOWNSHIP 14 NORTH RANGE 09 WEST OF THE GILA & SALT RIVER MERIDIAN, ARIZONA

SECS	SUBDIVISION																Acres	Kind of Entry or Purpose	Serial Number or Order Number	Action Date	Remarks			
	NE 1/4				NW 1/4				SW 1/4				SE 1/4									Lots	Other Description	
	NE	NW	SW	SE	NE	NW	SW	SE	NE	NW	SW	SE	NE	NW	SW	SE								
For orders affecting disposal or use of unidentified lands withdrawn for classification, minerals, water, and/or other public purposes, and Indian treaties, refer to Index to Miscellaneous Documents																								
2													X	X	X	X	PART 4	11N 3E,	181 60	IL BASE	84	8/27/1925		
32																		ALL,	640 00	IL BASE	89	1/9/192689	18N 9W,	
3																								
10																		MS 3981,	39 407	PATENT / ME	993915	1/8/1927		
9																		MS 3980,	41 319	PATENT / ME	993916	1/8/1927		
																		ALL SECS 2, 16, 32, 36,		STATE GRANT	ACT OF CONGRESS	1/25/1927	EXTENDS ACT OF 6/20/1910 TO MINERAL LANDS, SUBJECT TO PRIOR RIGHTS,	
3																								
4																		MS 3982,	181 521	PATENT / ME	1007190	9/12/1927	15N 9W,	
2		X	X			X	X	X	X	X	X						1-3, PART 4		458 08					
16																		ALL,	640 00	IL BASE	96	8/25/1928	18N 9W,	
3								X			X		X	X										
10	X	X		X			X	X			X	X	X	X	X	X								
11									X	X								640 00	SRHE	PHX-065586	1/10/1930		PART CANC. REL 5/12/1934,	
2									X	X	X				X			160 00	PATENT / FX	1035689	3/25/1930			
3																X		40 00	PATENT / FX	1035987	4/7/1930			
10	X			X																				
11					X	X												160 00	PATENT / FX	1035988	4/7/1930			
5																		MS 4084,	80 67	PATENT / ME	1036012	4/7/1930	15N 9W,	
3								X	X		X				X									
4																	4							
11						X	X						X	X	X									
13					X	X	X	X					X	X	X									
14	X																							
24	X			X														ALL LANDS WITHIN 25 FT OF CENTER LINE OF TRANSMISSION LINE,		O WDL PWR PROJECT	AR-774	7/18/1930	12N 4W, VACATED O 8/2/1965,	
11		X	X		X			X										160 00	PATENT / INDIAN RESERVATION X	1039203	7/29/1930			
11																X		40 00						
12										X	X			X	X			4N 3E,	160 00	SS MINERS HOSPITALS	7	4/25/1932		
13										X	X				X									
24		X	X		X	X	X	X	X	X		X	X	X										
25					X			X										640 00	SRHE	PHX-071418	9/28/1932		CANC 12/4/1936,	

TOWNSHIP 14 NORTH RANGE 09 WEST OF THE GILA & SALT RIVER MERIDIAN, ARIZONA

SECs	SUBDIVISION																Acres	Kind of Entry or Purpose	Serial Number or Order Number	Action Date	Remarks		
	NE 1/4				NW 1/4				SW 1/4				SE 1/4									Lots	Other Description
	NE	NW	SW	SE	NE	NW	SW	SE	NE	NW	SW	SE	NE	NW	SW	SE							
For orders affecting disposal or use of unidentified lands withdrawn for classification, minerals, water, and/or other public purposes, and Indian treaties, refer to Index to Miscellaneous Documents																							
16																X							
21	X	X	X	X	X	X	X	X	X	X	X	X	X	X	X	X		640 00	SRHE	PHX-071419	9/28/1932	REL 11/29/1935,	
13	X	X	X	X	X	X	X	X					X	X	X			480 00	HE	PHX-074196	7/11/1934	CANC 5/15/1936,	
1					X	X											3, 4						
2			X	X		X	X	X					X	X	X		1-4	639 68	PATENT / SRHE	1078012	8/30/1935		
12													X					40 00	IL	153	8/7/1936		
11									X				X	X	X			160 00	PATENT / HE	1096743	4/25/1938		
1			X	X					X	X	X	X	X	X	X	X		400 00					
12	X	X	X	X	X	X	X	X	X	X				X				440 00	IL	163	5/4/1938		
11														X									
13					X																		
14	X	X																160 00	PATENT / HE	1097557	6/9/1938		
15																		640 00	IL	185	11/3/1938	28N 6W,	
22																		640 00	IL	209	10/26/1940	19N 10W,	
21					X	X	X	X	X	X	X	X	X	X	X	X		520 00	PATENT / SX	1109619	11/18/1940		
23																		640 00	IL	214	3/3/1941	8N 6W,	
10									X	X							1, 2	157 44	PATENT / SX	1112075	9/25/1941		
7																		631 64					
18	X	X	X	X	X	X			X	X			X	X	X		1-6	614 68					
19					X				X	X			X				3, 4, 6, 7	312 52					
20	X		X	X									X	X	X	X	1	317 45					
26	X	X	X	X	X	X	X	X	X	X	X	X	X	X	X	X		480 00	PATENT / SX	1112600	11/28/1941		
34																		640 00	PATENT / SX	1113346	3/7/1942	5N 6W,	
25	X	X	X	X	X	X			X	X	X	X	X	X	X	X		560 00	PATENT / SX	1114069	6/4/1942		
26									X	X	X	X						160 00					
27																		640 00					
28																		640 00					
29	X	X	X	X									X	X	X	X		320 00					
30																		635 44					
31																		636 00					
33																		640 00					
35																		640 00	PATENT / SX	1114279	7/10/1942		

TOWNSHIP 14 NORTH RANGE 09 WEST OF THE GILA & SALT RIVER MERIDIAN, ARIZONA

SECS	SUBDIVISION																Acres	Kind of Entry or Purpose	Serial Number or Order Number	Action Date	Remarks			
	NE 1/4				NW 1/4				SW 1/4				SE 1/4									Lots	Other Description	
	NE	NW	SW	SE	NE	NW	SW	SE	NE	NW	SW	SE	NE	NW	SW	SE								
For orders affecting disposal or use of unidentified lands withdrawn for classification, minerals, water, and/or other public purposes, and Indian treaties, refer to index to Miscellaneous Documents																								
6																		ALL,	632 64	PATENT / SX	1114420	8/19/1942	OTHER TPS 7N 1W, 9N 1W, 11N 7W, 14 1/2N 6W, 11N 3E,	
20				X							X	X					2-7	9N 9W,	285 62	PATENT / SX	1115401	11/27/1942		
10			X								X		X	X	X	X	3							
11			X								X	X							399 89	PATENT / SRHE	1115780	12/21/1942		
4																								
6																								
7																								
8																								
9																		M&B, 11N 18W,		RAW TRANSMISSION LINE	PHX-080802	7/15/1943	CASE CLOSED 10/25/1982,	
25				X			X												80 00					
29				X	X	X	X	X	X	X	X	X						15S 10E,	320 00	PATENT / SX	1120356	12/3/1945		
3			X	X			X	X	X	X	X	X		X	X		1-3, 5-7							
10																	4-6		642 92	PATENT / PS	1147911	11/12/1954		
4							X	X	X	X														
8			X								X	X	X	X										
9					X	X																		
17	X	X		X			X	X	X	X								15N 10W,		RAW TRANSMISSION LINE AND WATER PIPELINE	AR-012048	9/18/1956	PERPETUAL, APPVD FOR PD ONLY,	
8																	5, 10, 11							
9					X	X											1							
17	X	X					X	X									3, 4			RAW TRANSMISSION LINE	AR-012072	11/5/1956	TO TERM 11/4/2006, APPVD FOR PD ONLY, PART REL 8/10/1972,	
9																X								
16	X																1, 2, 5							
17			X				X				X	X					4, 5							
19																	1			RAW TELEPHONE AND TELEGRAPH LINE	AR-012771	12/10/1956	TO TERM 12/9/2006, APPVD FOR PD ONLY,	
17																								
18																								
19																								
20																	MS 4413	MS 4413,	39 79	PATENT / ME	1188076	11/12/1958		
																		TP DEFICIT,	0 32	IL BASE	279	1/11/1961	5N 14E,	
19																			0 006					
30																	MS 4578	MS 4578, 14N 10W,	140 195	PATENT / ME	02-63-0036	9/21/1962	(AR-031261),	

TOWNSHIP 14 NORTH RANGE 09 WEST OF THE GILA & SALT RIVER MERIDIAN, ARIZONA

SECS	SUBDIVISION																Acres	Kind of Entry or Purpose	Serial Number or Order Number	Action Date	Remarks		
	NE 1/4				NW 1/4				SW 1/4				SE 1/4									Lots	Other Description
	NE	NW	SW	SE	NE	NW	SW	SE	NE	NW	SW	SE	NE	NW	SW	SE							
For orders affecting disposal or use of unidentified lands withdrawn for classification, minerals, water, and/or other public purposes, and Indian treaties, refer to Index to Miscellaneous Documents																							
13				X	X	X	X	X					X	X	X			R/W HIGHWAY	AR-032983	2/12/1964	PERPETUAL, RS 2477.		
3									X	X		X			X								
4																4							
11											X	X			X	X	X						
13					X	X	X	X					X	X	X								
14	X																						
24	X			X													12N 4W,	O VACATED PWR PROJECT AR-774, O 7/18/1930	AR-035179	8/2/1965			
13						X	X	X					X	X									
24	X	X		X									X				13N 8W,	R/W TELEPHONE AND TELEGRAPH LINE	AR-034625	9/27/1965	TO TERM 9/9/2015,		
30																MS 4623,	11 331	PATENT / ME	02-66-0058	11/8/1965	(AR-034821).		
13	X	X	X	X	X	X	X	X	X	X	X	X	X	X	X	X		600 00					
14			X	X									X	X	X	X		240 00					
21	X	X	X														120 00	IL	428	5/6/1968	OTHER TPS 8N 30E, 9N 4E, 9N 5E, 13N 16E, 14N 13E, 14N 14E, 14N 15E, 15N 5E, 15N 6E, 17N 31E, 35N 10E,		
24																	640 00	ALL,					
32																	640 00	ALL,	429	5/16/1968	8N 27E,		
1																1, 2	80 00	IL	456	1/9/1969	OTHER TPS 12N 5W, 14N 10W, 19N 14W, 8N 30E, 9N 23E, 14N 2E, 19N 8E, 21N 2E, 21N 3E, 21N 6E, 22N 2E, 22N 4E, 24S 24E,		
11	X			X												4N 5E,		O PROPOSED CL FOR MULTIPLE USE MANAGEMENT	A-3478	2/7/1969	SEGREGATES THE PUBLIC LANDS FROM ALL FORMS OF APPROPRIATION UNDER AGRICULTURAL, SALE EXCHANGE, SELECTION, MINING AND MINERAL LEASING LAWS, PUB IN FR 2/13/1969, O CL 6/29/1970, PUB IN FR 7/11/1970, MINERAL SEG TO TERM 2/26/1981, CL TERM 10/7/1981,		
14					X	X	X	X															
16																	195 00	E2SESE, SWSESE, E2NWSESE,	O CL / PX	A-892	1/7/1972		
8																4							
9						X	X	X					X	X	X			EXCLUSIVE OF PATENTED RUBY MINING CLAIM,	R/W TRANSMISSION LINE	A-5961	4/20/1972	PERPETUAL, 14N 2W,	
11	X			X													80 00	O CL / R&PP	A-1842	5/19/1972	SEGREGATES THE PUBLIC LANDS FROM ALL FORMS OF APPROPRIATION AND LOCATION, INCLUDING THE MINING AND MINERAL LEASING LAWS,		
14					X	X	X	X															
16																	195 00	E2SESE, SWSESE, E2NWSESE,	PATENT / PX	02-73-0013	8/16/1972	(A-892),	
11	X			X													80 00	PATENT / R&PP	02-73-0027	9/19/1972	(A-1842), NOT OPEN TO ME, SUBJECT TO MINERAL LEASING ACT,		
5					X	X	X	X	X	X	X	X			X								

TOWNSHIP 14 NORTH RANGE 09 WEST OF THE GILA & SALT RIVER MERIDIAN, ARIZONA

SECS	SUBDIVISION																Acres	Kind of Entry or Purpose	Serial Number or Order Number	Action Date	Remarks			
	NE 1/4				NW 1/4				SW 1/4				SE 1/4									Lots	Other Description	
	NE	NW	SW	SE	NE	NW	SW	SE	NE	NW	SW	SE	NE	NW	SW	SE								
	For orders affecting disposal or use of unidentified lands withdrawn for classification, minerals, water, and/or other public purposes, and Indian treaties, refer to Index to Miscellaneous Documents																							
18	X	X	X	X	X				X	X			X	X	X		1-5							
19					X				X	X			X				3, 4, 6, 7							
20	X		X	X	X								X	X	X	X	1, 4-7							
21			X	X	X	X	X	X	X	X	X	X	X	X	X	X								
25																		ALL,						
26																		ALL,						
27																		ALL,						
28																		ALL,						
29																		ALL,						
33																		ALL,						
34																		ALL,						
35																		ALL, LD TP 16 1/2N 9W,	NORA	A-23217	3/21/1988	SEGREGATED FROM THE MINING LAWS AND MINERAL LEASING LAWS, SEG TO TERM 3/20/1990,		
4																	8-10	PART MS 2818 AND MS 4736A, MS 4736B,						
5						X				X	X						5	W2SENW, W2E2SENW, W2E2NESW, W2NESW, S2NESESW, W2SESW, SESESW, NESWSE, S2SWSE,						
6			X	X					X	X			X	X	X	X	1-7						MINERALS ONLY,	
7				X					X								1, 2						MINERALS ONLY,	
8																	3, 12	S2SWNE, W2E2NWNE, W2NWNE, S2SESENE, N2NENW, SEENW,						
9																		SWSSEW,						
10																	1, 2		NORA / PX	A-22880	6/30/1988	MINERALS ONLY, SEGREGATES THE LANDS FROM THE OPERATION OF THE PUBLIC LAND LAWS, SEG TO TERM 6/29/1990, OTHER TPS 14N 10W 15N 9W, 15N 10W, 16N 10W, 16N 13W, 16 1/2N 13W, 17N 13W, 20N 18W, 21N 18W,		
6			X	X					X	X			X	X	X	X	1-7							
7				X					X								1, 2							
10																	1, 2		PATENT / CMI	02-89-0001	10/5/1988	(A-22880), OTHER TPS 14N 10W, 15N 9W,		
4																	8-10, 26							
5						X				X	X						5	W2SENW, W2E2SENW, W2E2NESW, W2NESW, S2NESESW, W2SESW, SESESW, NESWSE, S2SWSE,						

TOWNSHIP 14 NORTH RANGE 09 WEST OF THE GILA & SALT RIVER MERIDIAN, ARIZONA

SECS	SUBDIVISION																Acres	Kind of Entry or Purpose	Serial Number or Order Number	Action Date	Remarks		
	NE 1/4				NW 1/4				SW 1/4				SE 1/4									Lots	Other Description
	NE	NW	SW	SE	NE	NW	SW	SE	NE	NW	SW	SE	NE	NW	SW	SE							
For orders affecting disposal or use of unidentified lands withdrawn for classification, minerals, water, and/or other public purposes, and Indian treaties, refer to Index to Miscellaneous Documents																							
8																	3, 12	S2SWNE, W2E2NWNE, W2NWNE, S2SESENE, N2NENW, SENENW,					
9																		SWSENW,	PATENT / PX	02-89-0002	10/5/1988	(A-22880), OTHER TPS 15N 9W, 15N 10W, 16N 10W,	
21			X						X	X	X	X	X	X	X	X							
25																		ALL,					
26	X	X	X	X									X	X	X	X							
27					X	X	X	X	X	X	X	X											
28																		ALL,					
29	X	X	X	X									X	X	X	X							
33																		ALL,					
34	X	X	X	X	X	X	X	X	X	X	X	X											
35																		ALL, LD TP 10N 6W,	PATENT / CMI	02-89-0006	10/26/1988	(A-23217-A),	
21					X	X	X																
26					X	X	X	X				X											
27	X	X																					
29									X														
34													X	X	X	X		LD TP 10N 6W,	NORA	AZA-25033	1/22/1991	SEGREGATES THE MINERAL INTEREST FROM THE OPERATION OF THE MINING LAWS AND MINERAL LEASING LAWS, SEG TO TERM 1/21/1993,	
21					X	X	X																
26					X	X	X	X				X											
27	X	X																					
34													X	X	X	X		LD TP 10N 6W,	PATENT / PX	02-91-0011	4/3/1991	MINERALS ONLY, AZA-25033-A),	
10									X			X				X							
11											X								NORA / CMI	AZA-21807	8/8/1991	SEGREGATES THE MINERAL INTEREST TO THE EXTENT THAT THEY WILL NOT BE OPEN TO APPROPRIATION UNDER THE MINING LAWS AND MINERAL LEASING LAWS, SEG TO TERM 8/7/1993, APLN REJECTED AND CASE CLOSED 3/4/1992,	
7	X	X	X	X					X	X	X	X	X	X	X	X						MINERALS ONLY,	
8					X						X						1, 2, 5-11	SWNENW,					
9											X				X	X	2, 3, 7-12	S2NENE, SENWNE,					
10									X	X												MINERALS ONLY,	
18	X	X	X	X	X	X	X	X											APLN / PX	AZA-28633	7/20/1994	MINERALS ONLY, SEGREGATES THE LANDS FROM THE PUBLIC LAND LAWS, MINING LAWS, AND MINERAL LEASING LAWS, SEG TO TERM 7/19/1999, OTHER TPS 14N 10W, 15N 10W, 17N 13W, 18N 13W, 22N 18W, 23N 18W, 1N 14E, 1N 15E, 17S 12E, 17S 13E, 18S 12E,	

TOWNSHIP 14 NORTH RANGE 09 WEST OF THE GILA & SALT RIVER MERIDIAN, ARIZONA

SECS	SUBDIVISION																Acres	Kind of Entry or Purpose	Serial Number or Order Number	Action Date	Remarks		
	NE 1/4				NW 1/4				SW 1/4				SE 1/4									Lots	Other Description
	NE	NW	SW	SE	NE	NW	SW	SE	NE	NW	SW	SE	NE	NW	SW	SE							
For orders affecting disposal or use of unidentified lands withdrawn for classification, minerals, water, and/or other public purposes, and Indian treaties, refer to Index to Miscellaneous Documents																							
30	X	X	X	X	X				X	X			X	X	X	X	1-4	INCL MS 4578 WITHIN SEC,					
31	X	X	X	X	X				X	X			X	X	X	X	1-4						
32					X	X	X	X	X	X	X	X						LD TP 11N 8W,		OPENING ORDER	AZA-22796	7/21/1998	AT 9 00 AM ON 8/20/1998 THE LANDS WILL BE OPEN TO ENTRY UNDER THE GENERAL MINING LAWS AND MINERAL LEASING LAWS,

Land Patent Details						
Accession Nr: 1114279 Document Type: Serial Patent State: Arizona Issue Date: 7/10/1942 Cancelled: No						
Names On Document			Miscellaneous Information			
STATE OF ARIZONA			Land Office:	Phoenix		
			US Reservations:	Yes		
Military Rank: --			Mineral Reservations:	Yes		
			Tribes:	---		
			Militia:	---		
			State In Favor Of:	--		
			Authority:	June 28, 1934: Exchange State Taylor Act (48 Stat. 1269)		
Document Numbers			Survey Information			
Document Nr:	075485		Total Acres:	6191.76		
Misc. Doc. Nr:	---		Survey Date:	---		
BLM Serial Nr:	AZPHX 0075485		Geographic Name:	---		
Indian Allot. Nr:	---		Metes/Bounds:	No		
Land Descriptions						
State	Meridian	Twp - Rng	Aliquots	Section	Survey #	County
AZ	Gila-Salt River	014N - 009W	SW ¹ / ₄	26		Yavapai
REMARKS: ALL MINERALS RESERVED TO US						
AZ	Gila-Salt River	014N - 009W		27		Yavapai
REMARKS: ALL MINERALS RESERVED TO US						
AZ	Gila-Salt River	014N - 009W		28		Yavapai
REMARKS: ALL MINERALS RESERVED TO US						
AZ	Gila-Salt River	014N - 009W	E ¹ / ₂	29		Yavapai
REMARKS: ALL MINERALS RESERVED TO US						
AZ	Gila-Salt River	014N - 009W		30		Yavapai
REMARKS: ALL MINERALS RESERVED TO US						
AZ	Gila-Salt River	014N - 009W		31		Yavapai
REMARKS: ALL MINERALS RESERVED TO US						
AZ	Gila-Salt River	014N - 009W		33		Yavapai
REMARKS: ALL MINERALS RESERVED TO US						
AZ	Gila-Salt River	014N - 009W		35		Yavapai
REMARKS: ALL MINERALS RESERVED TO US						
AZ	Gila-Salt River	014N - 010W	Lot/Trct 1	1		Yavapai
REMARKS: LOT 1 OR NENE QUARTER ALL MINERALS RESERVED TO US						
AZ	Gila-Salt River	014N - 010W	Lot/Trct 2	1		Yavapai
REMARKS: LOT 2 OR NWNE QUARTER ALL MINERALS RESERVED TO US						
AZ	Gila-Salt River	014N - 010W	Lot/Trct 3	1		Yavapai
REMARKS: LOT 3 OR NENW QUARTER ALL MINERALS RESERVED TO US						
AZ	Gila-Salt River	014N - 010W	Lot/Trct 4	1		Yavapai
REMARKS: LOT 4 OR NWNW QUARTER ALL MINERALS RESERVED TO US						
AZ	Gila-Salt River	014N - 010W	S ¹ / ₂ N ¹ / ₂	1		Yavapai
REMARKS: ALL MINERALS RESERVED TO US						
AZ	Gila-Salt River	014N - 010W	S ¹ / ₂	1		Yavapai
REMARKS: ALL MINERALS RESERVED TO US						
AZ	Gila-Salt River	014N - 010W	E ¹ / ₂	12		Yavapai
REMARKS: ALL MINERALS RESERVED TO US						
AZ	Gila-Salt River	014N - 010W	E ¹ / ₂ W ¹ / ₂	12		Yavapai
REMARKS: ALL MINERALS RESERVED TO US						
AZ	Gila-Salt River	014N - 010W	W ¹ / ₂ SW ¹ / ₄	12		Yavapai
REMARKS: ALL MINERALS RESERVED TO US						
AZ	Gila-Salt River	014N - 010W	SW ¹ / ₄ NW ¹ / ₄	12		Yavapai
REMARKS: ALL MINERALS RESERVED TO US						
AZ	Gila-Salt River	014 ¹ / ₂ N - 008W		27		Yavapai
REMARKS: ALL MINERALS RESERVED TO US						

The United States of America,

To all to whom these presents shall come, Greeting:

WHEREAS, under the provisions of Section 8 of the Act of June 28, 1934 (48 Stat. 1269), entitled "An Act To stop injury to the public grazing lands by preventing overgrazing and soil deterioration, to provide for their orderly use, improvement, and development, to stabilize the livestock industry dependent upon the public range, and for other purposes," as amended by Section 3 of the Act of June 26, 1936 (49 Stat. 1976), the State of Arizona, in exchange for certain other lands situated in said State, has selected the following described tracts of land:

Gila and Salt River Meridian, Arizona.

Township fourteen north of Range nine west.

The southwest quarter of Section twenty-six, the Sections twenty-seven and twenty-eight, the east half of Section twenty-nine and the Sections thirty, thirty-one, thirty-three and thirty-five.

Township fourteen north of Range ten west.

The Section one and the east half, the east half of the west half, the west half of the southwest quarter and the southwest quarter of the northwest quarter of Section twelve.

Township fourteen and one-half north of Range eight west.

The Section twenty-seven, containing, in the aggregate, six thousand one hundred ninety-one acres and seventy-six hundredths of an acre, according to the Official Plats of the Surveys of the said Lands, on file in the GENERAL LAND OFFICE.

NOW KNOW YE, That the UNITED STATES OF AMERICA, in consideration of the premises, and in conformity with the said Acts of Congress, HAS GIVEN AND GRANTED, and by these presents DOES GIVE AND

1114279

GRANT, unto the said State of Arizona, in fee simple, the tracts of land above described; TO HAVE AND TO HOLD the same, together with all the rights, privileges, immunities, and appurtenances, of whatsoever nature, thereunto belonging, unto the said State of Arizona, and to its assigns forever; subject to any vested and accrued water rights for mining, agricultural, manufacturing, or other purposes, and rights to ditches and reservoirs used in connection with such water rights, as may be recognized and acknowledged by the local customs, laws, and decisions of courts; and there is reserved from the lands hereby granted, a right of way thereon for ditches or canals constructed by the authority of the United States. Reserving, also, to the United States, all minerals in the lands so granted, together with the right to prospect for, mine, and remove the same, as authorized by the provisions of said section 8, as amended as aforesaid. *ok*

IN TESTIMONY WHEREOF, I, **Franklin D. Roosevelt,**

President of the United States of America, have caused these letters to be made Patent, and the Seal of the General Land Office to be hereunto affixed.

GIVEN under my hand, at the City of Washington, the **TENTH**

(SEAL)

day of **JULY** in the year of our Lord one thousand nine hundred and **FORTY-TWO** and of the Independence of the United States the one hundred and **SIXTY-SEVENTH**

By the President: *Franklin D. Roosevelt*

By *Alice M. Grove* Assistant Secretary.
R. S. Clinton

1114279 Chief, Patents Division, **General Land Office.**

RECORD OF PATENTS: Patent Number

RUN TIME: 01:08 PM

DEPARTMENT OF INTERIOR
BUREAU OF LAND MANAGEMENT

RUN DATE: 09/22/2017
Page 1 of 1

Input Parameters for Geographic Report with Land

System Id = CR

Admin State = AZ

Geo State =

Casetype Begins With

Case Disp Txt = AUTHORIZED, CANCELLED, EXPIRED, PENDING, REJECTED, RELINQUISHED, VOID, WITHDRAWN

Mer Twp Rng = 14 0140N 0090W

Section = 026, 999

Mtrs =

Commodity =

Commodity Txt =

Pending Org =

Pend Org Decode =

Total Rows Returned: 2

NO WARRANTY IS MADE BY BLM FOR USE OF THE DATA
FOR PURPOSES NOT INTENDED BY BLM

RUN TIME: 01:04 PM

UNITED STATES DEPARTMENT OF INTERIOR
BUREAU OF LAND MANAGEMENT
GEOGRAPHIC REPORT WITH LAND
Sorted by Serial Number

RUN DATE: 09/22/2017

Adm State: AZ

Page 1 of 1

Serial Number: AZA 023217AF
Total Case Acres: 135,728.110

<u>Casetype</u>	<u>Case Disp</u>	14	0140N	0090W	<u>Sect</u>	<u>Sur Typ</u>	<u>Sur Num</u>	<u>Suff</u>	<u>Subdivision</u>	<u>Act Pend</u>
220100	AUTHORIZED				026	ALIQ			E2;	

Serial Number: AZA 025033AF
Total Case Acres: 3,995.090

<u>Casetype</u>	<u>Case Disp</u>	14	0140N	0090W	<u>Sect</u>	<u>Sur Typ</u>	<u>Sur Num</u>	<u>Suff</u>	<u>Subdivision</u>	<u>Act Pend</u>
220100	AUTHORIZED				026	ALIQ			E2W2,NWNW;	

TOWNS. 14 NORTH RANGE 9 WEST OF THE GILA AND SALT RIVER MERIDIAN, ARIZONA

YAVAPAI COUNTY
KINGMAN FIELD OFFICE

STATUS OF PUBLIC DOMAIN
LAND AND MINERAL TITLES

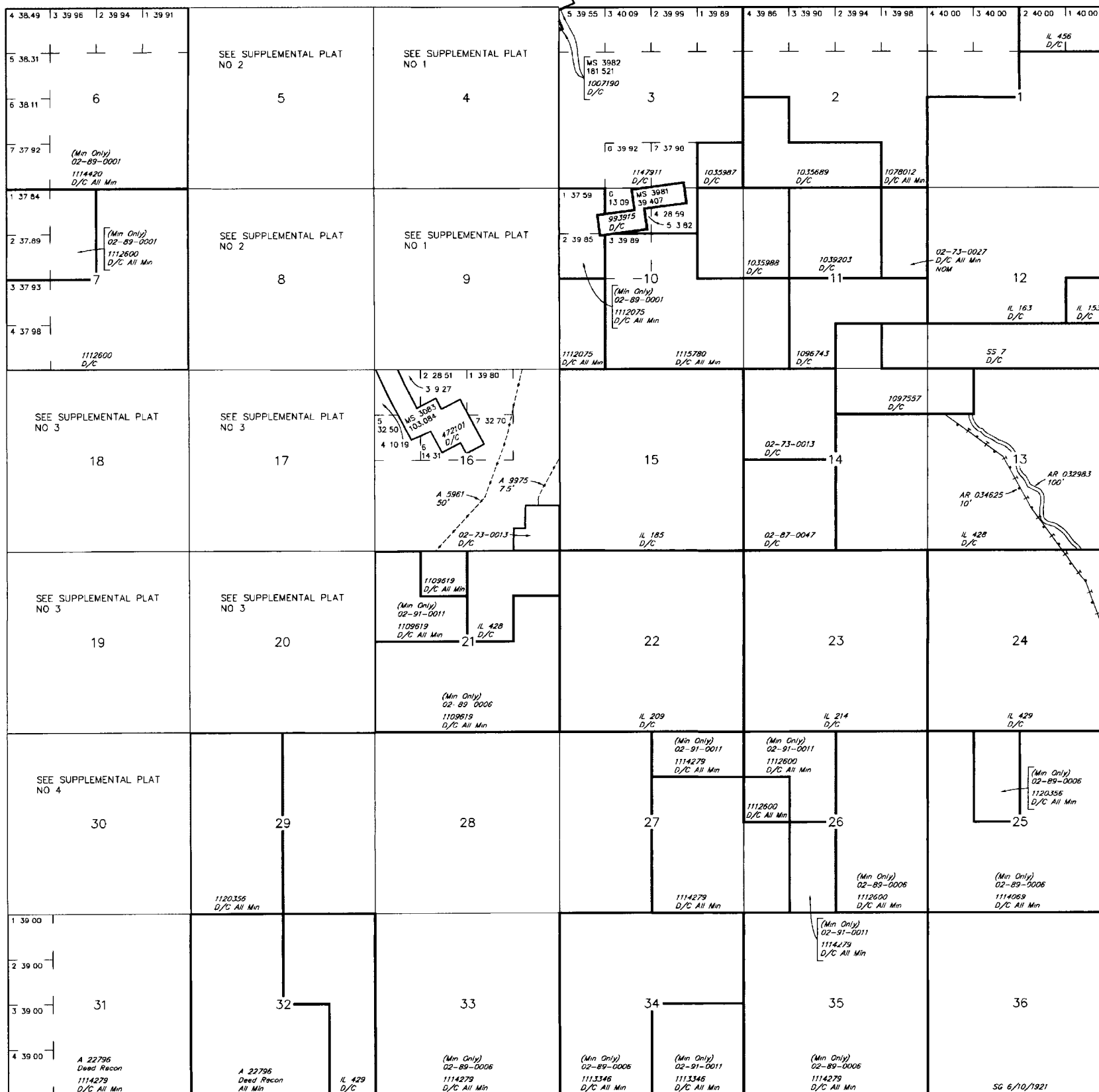

INDEX TO SEGREGATED TRACTS					
RESURVEY	ORIGINAL SURVEY				
	TRACT NO	T	R	SEC	SUBDIVISION

FOR ORDERS AFFECTING DISPOSAL OR USE OF UNIDENTIFIED LANDS WITHDRAWN FOR CLASSIFICATION, MINERALS, WATER AND/OR OTHER PUBLIC PURPOSES, REFER TO INDEX OF MISCELLANEOUS DOCUMENTS

- MDS 333 NE
- 334 NW
- 335 SW
- AZA 31478 R/W 25'
- Sec 8 Lot 11
- Sec 17 Lot 3, W1/2NE1/4, NE1/4SW1/4
- Sec 32 E1/2W1/2

Lat 34°30'03"N
Long 113°08'58"W

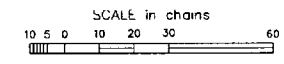

WARNING STATEMENT
This plot is the Bureau's Record of Title, and should be used only as a graphic display of the township survey data. Recordation herein do not reflect title changes which may have been affected by lateral movements of rivers or other bodies of water. Refer to the cadastral surveys for official survey information.

CURRENT TO	NW	GSR Mer
8-28-2015	ACAD	T 14 N
		R 9 W